

拆件器使用方法, 仅为示例  
Usage of Brick Separator. Just for the sample

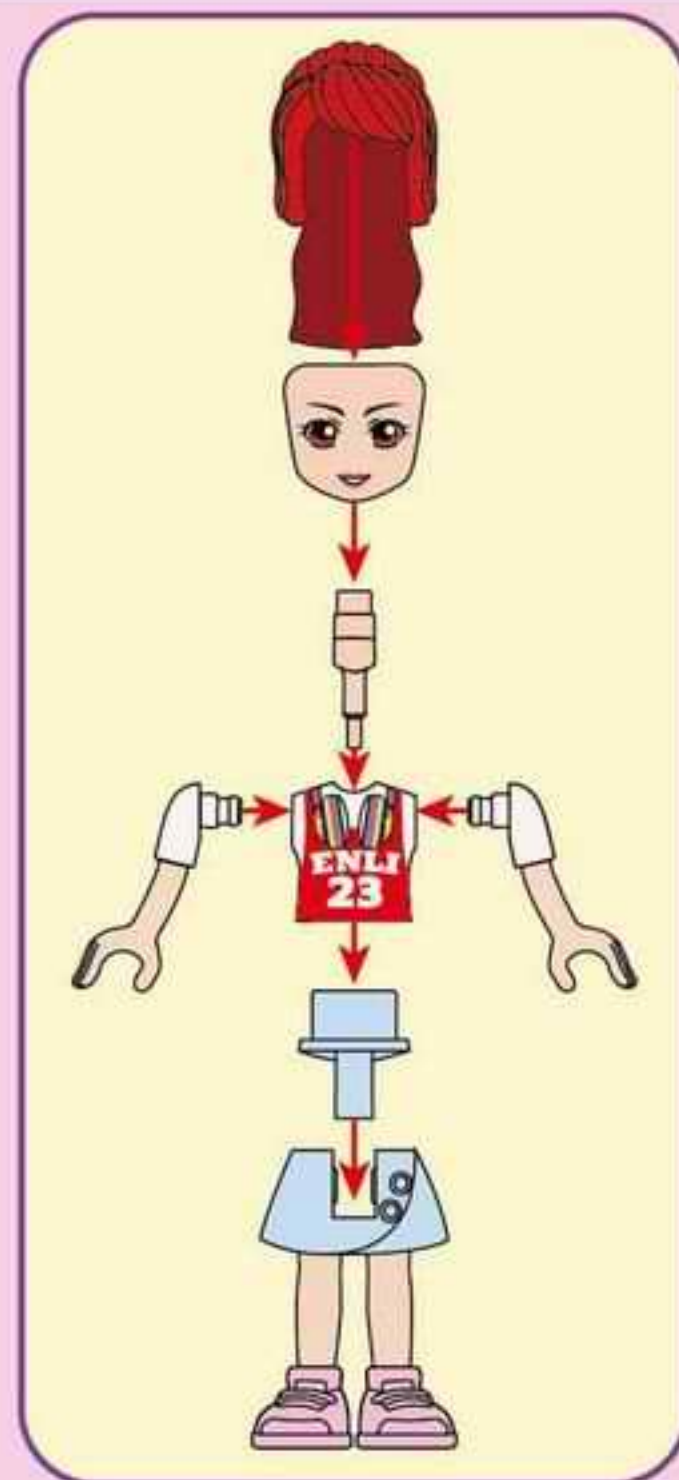

1

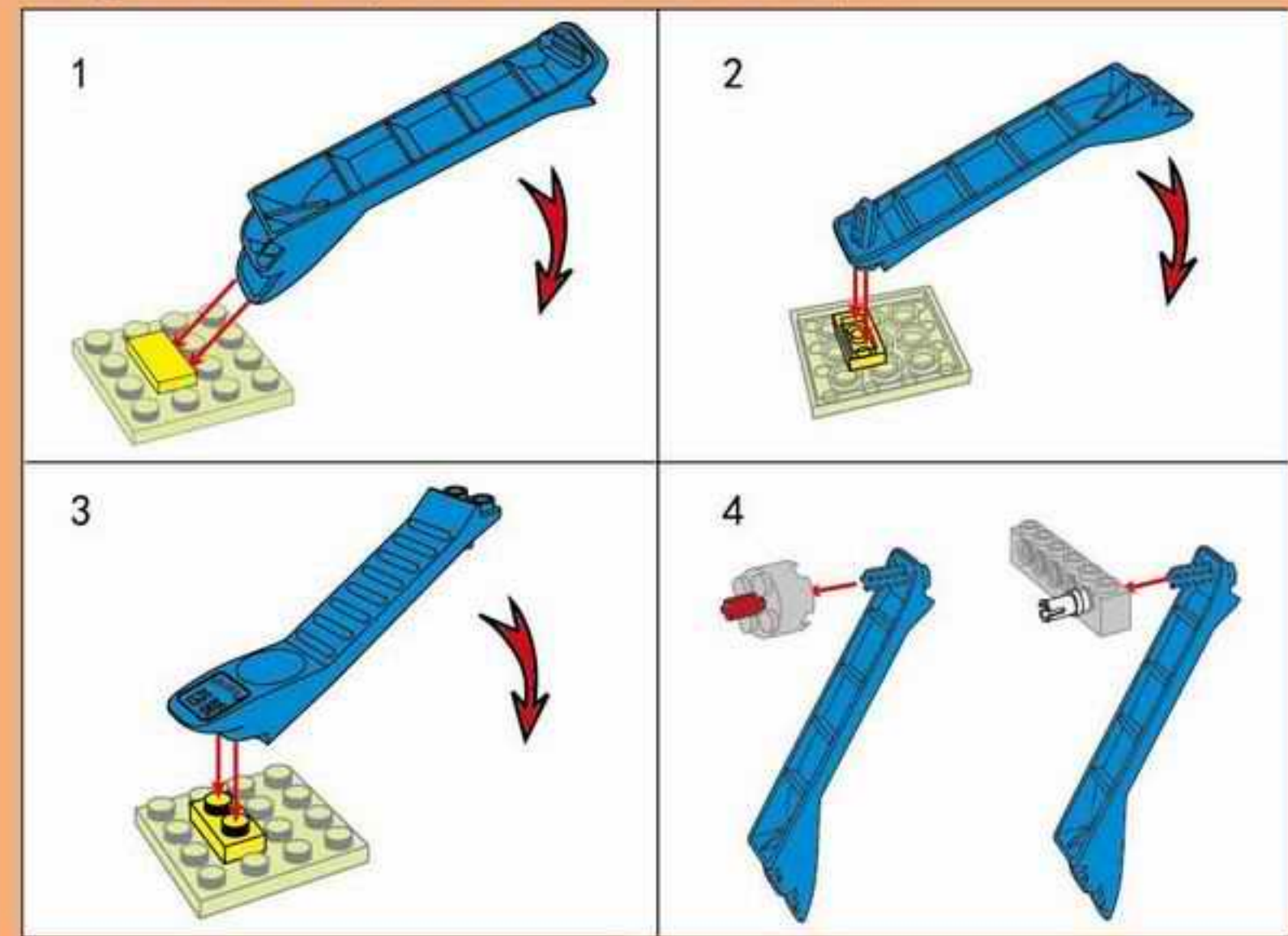

1x

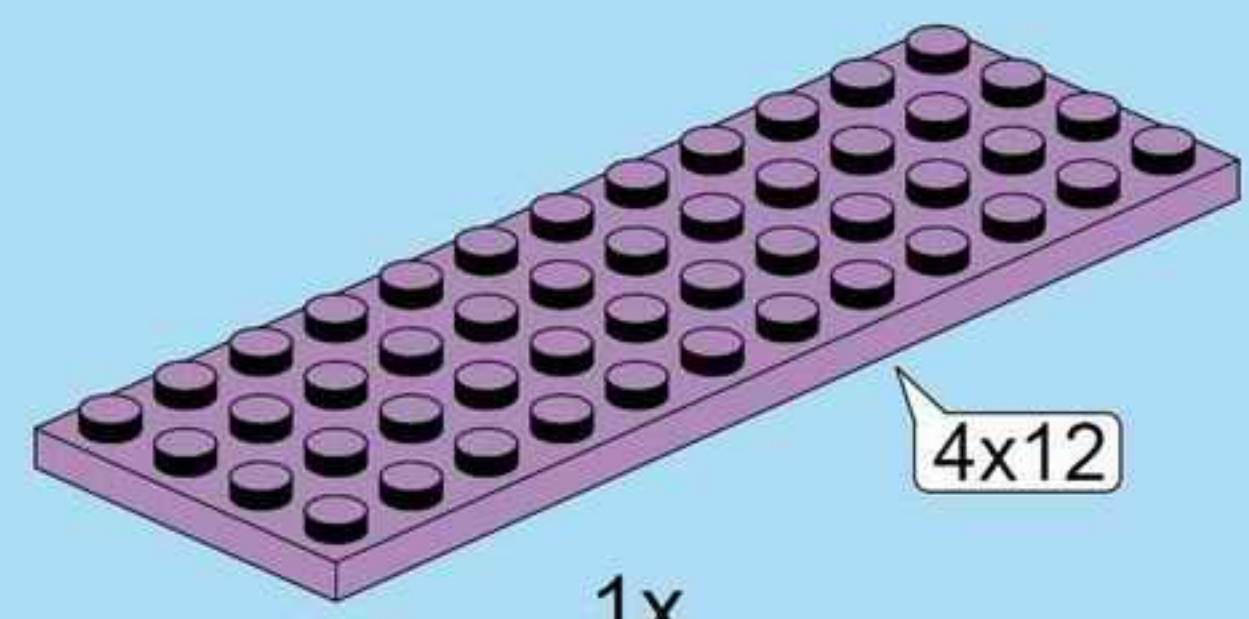

4x12

1x

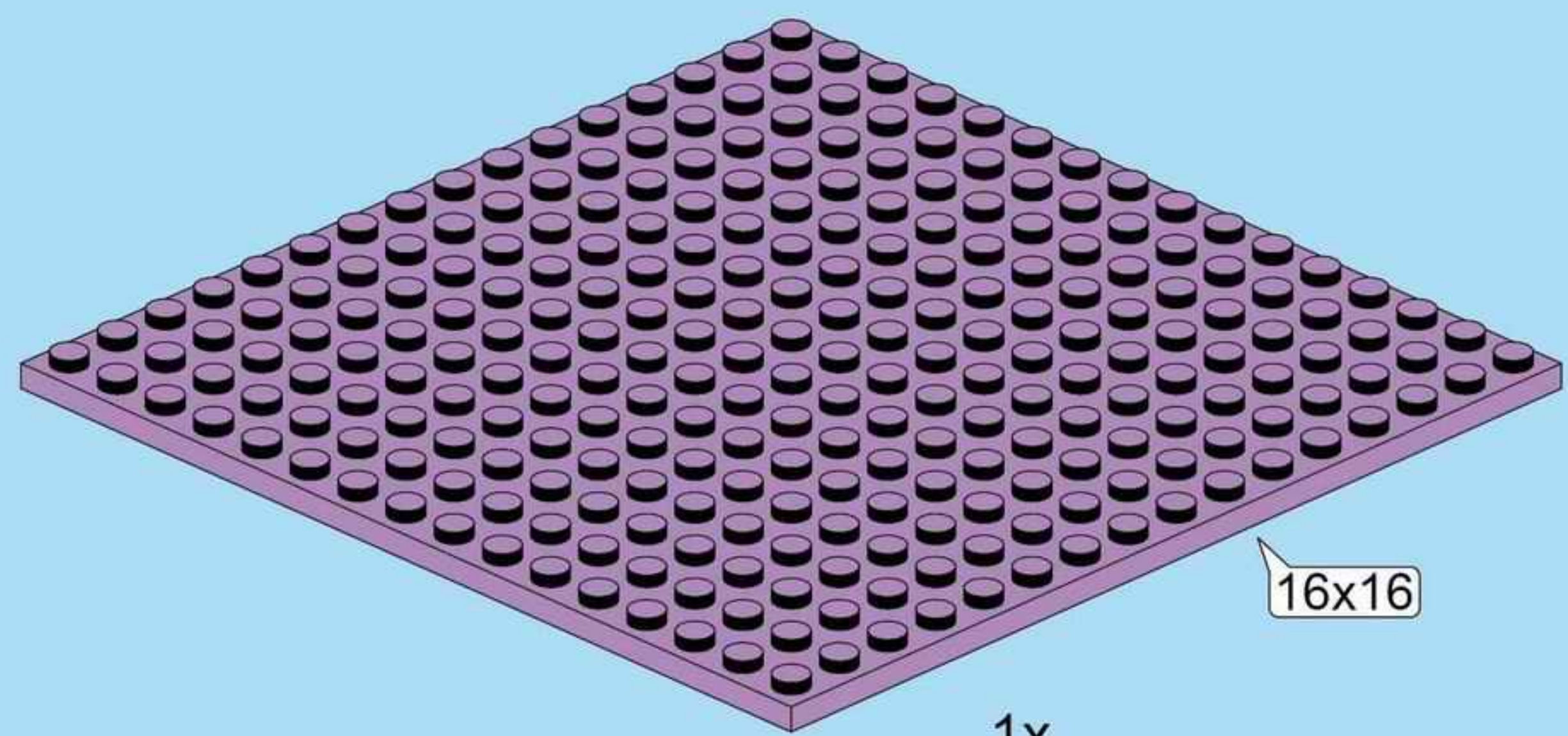

16x16

1x

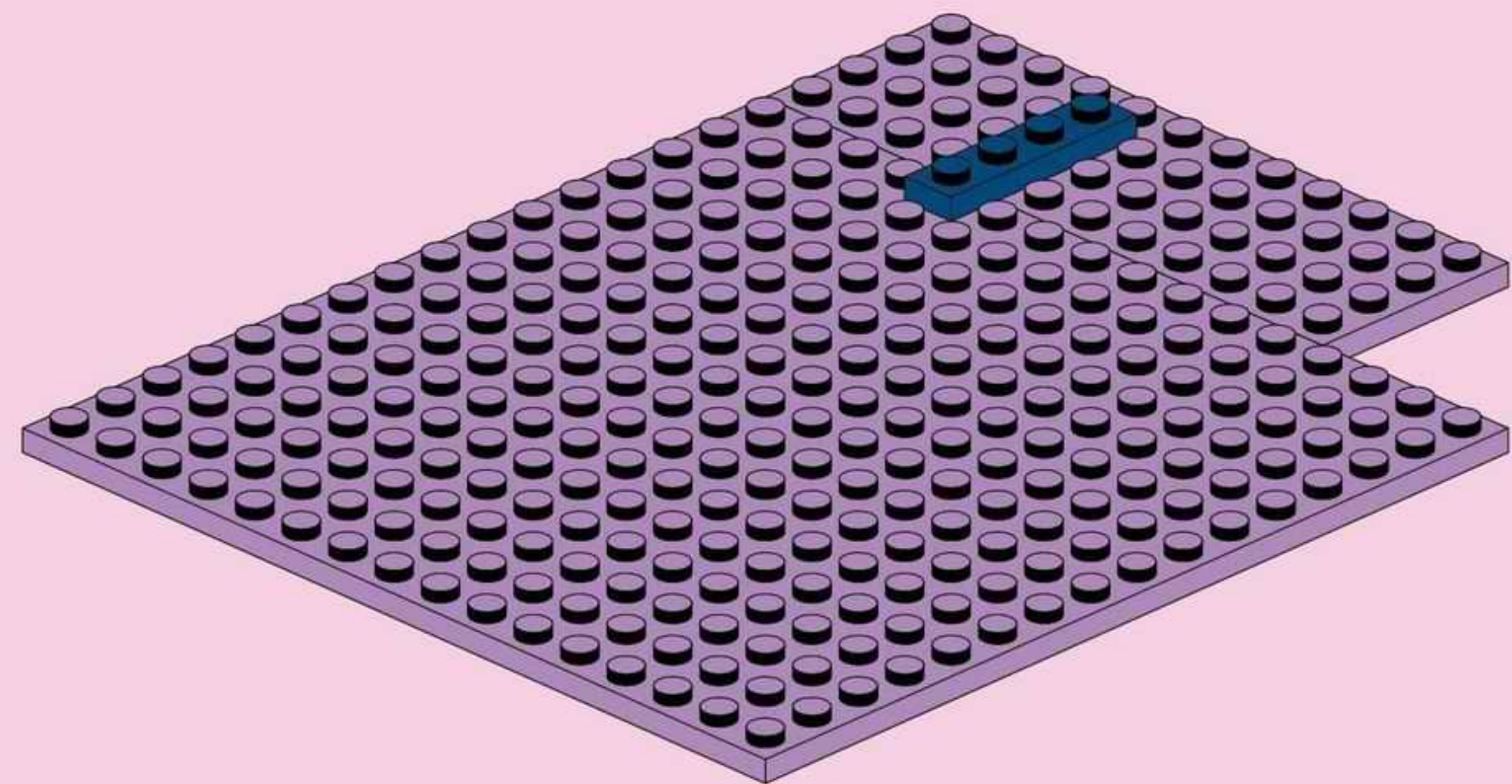

2

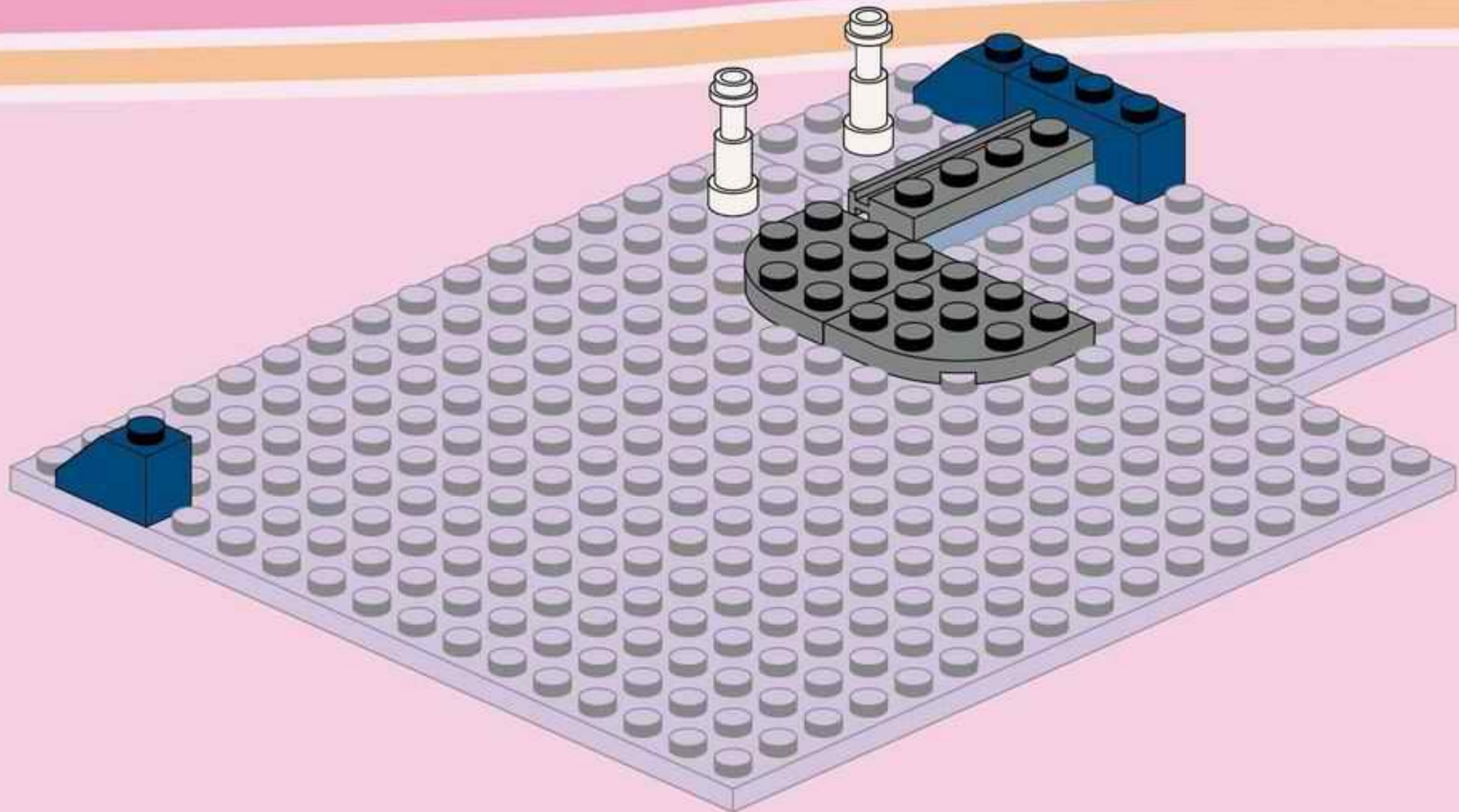
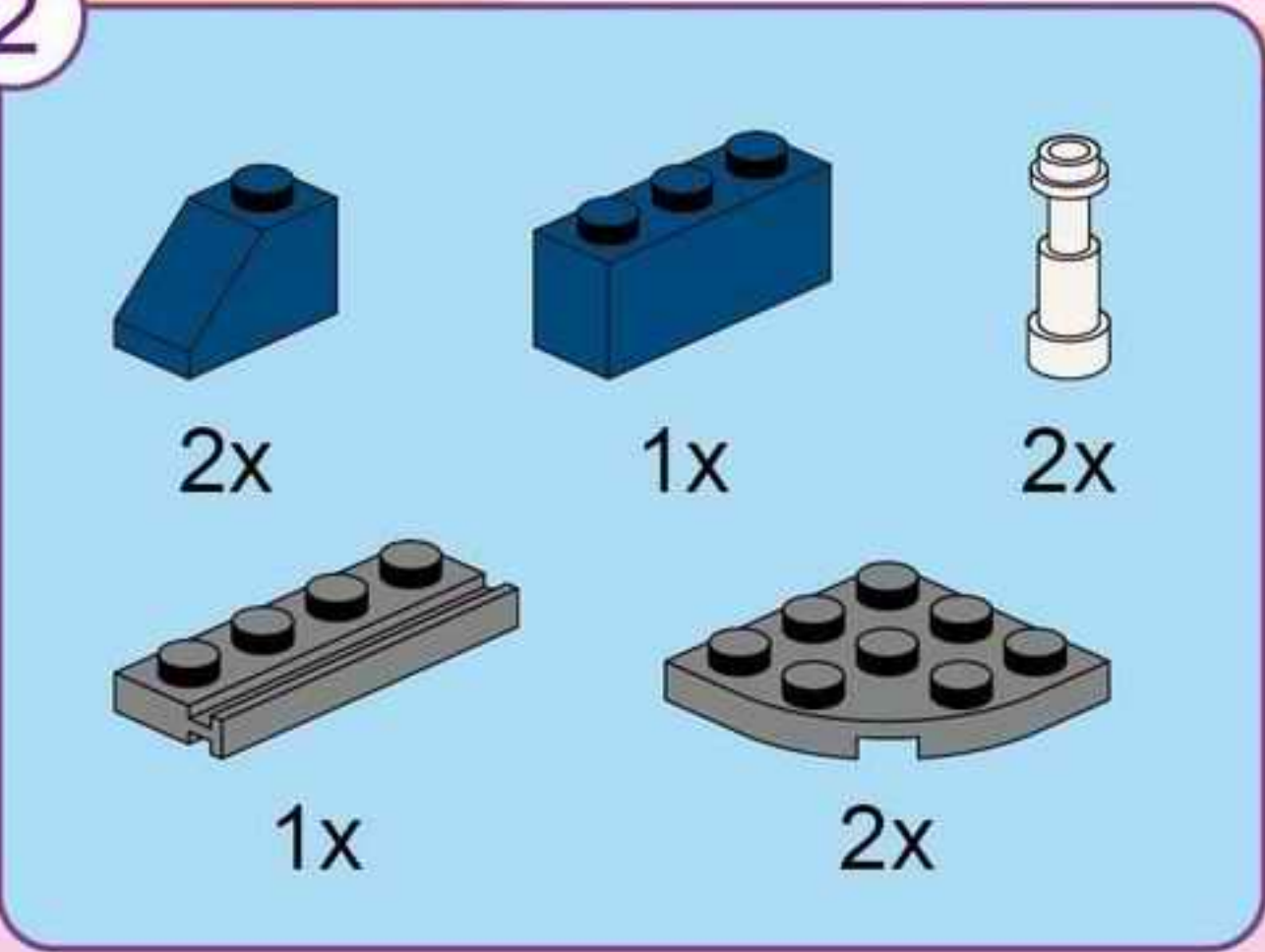

3

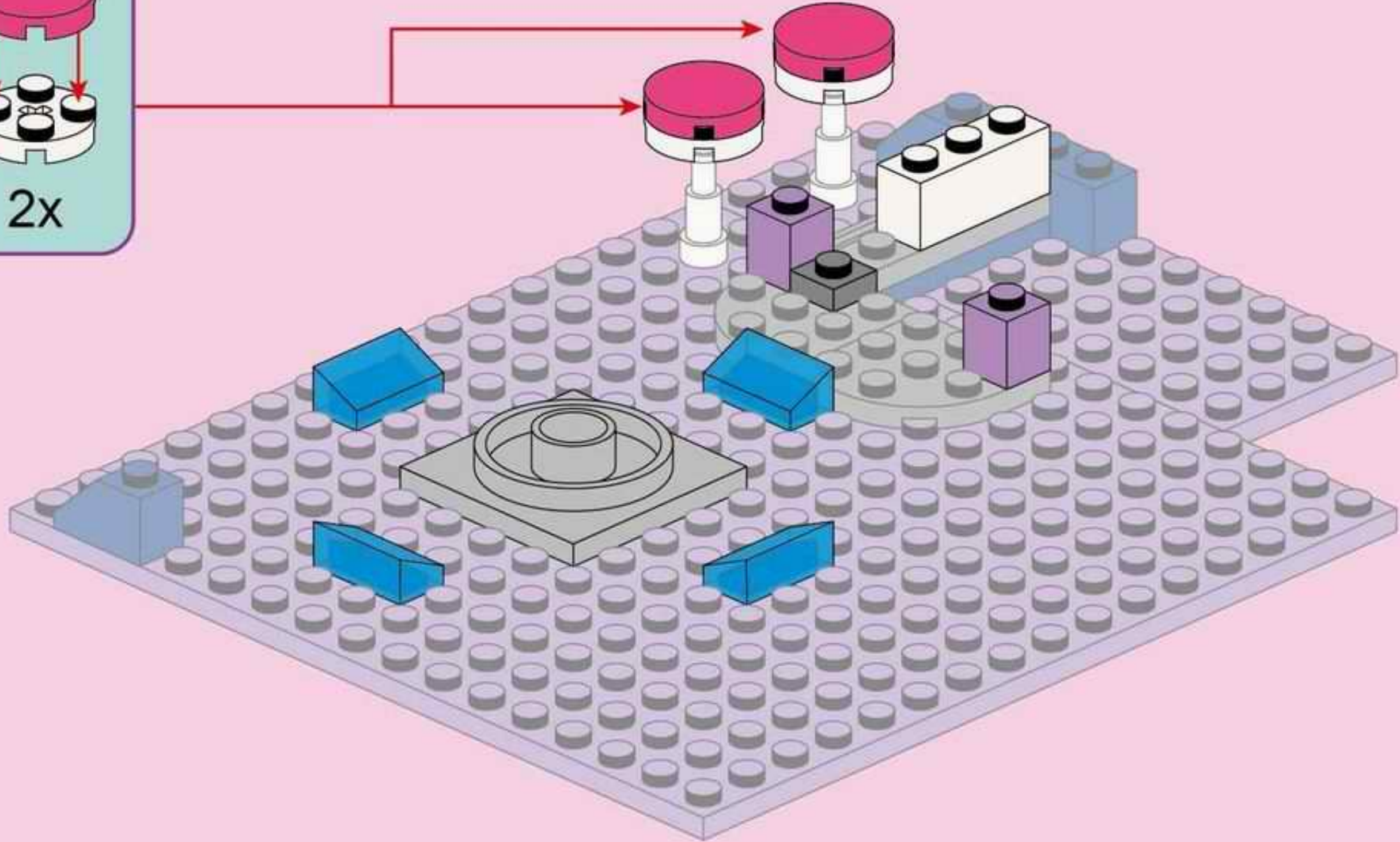
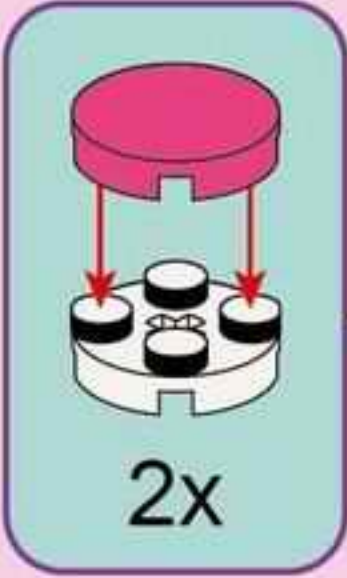
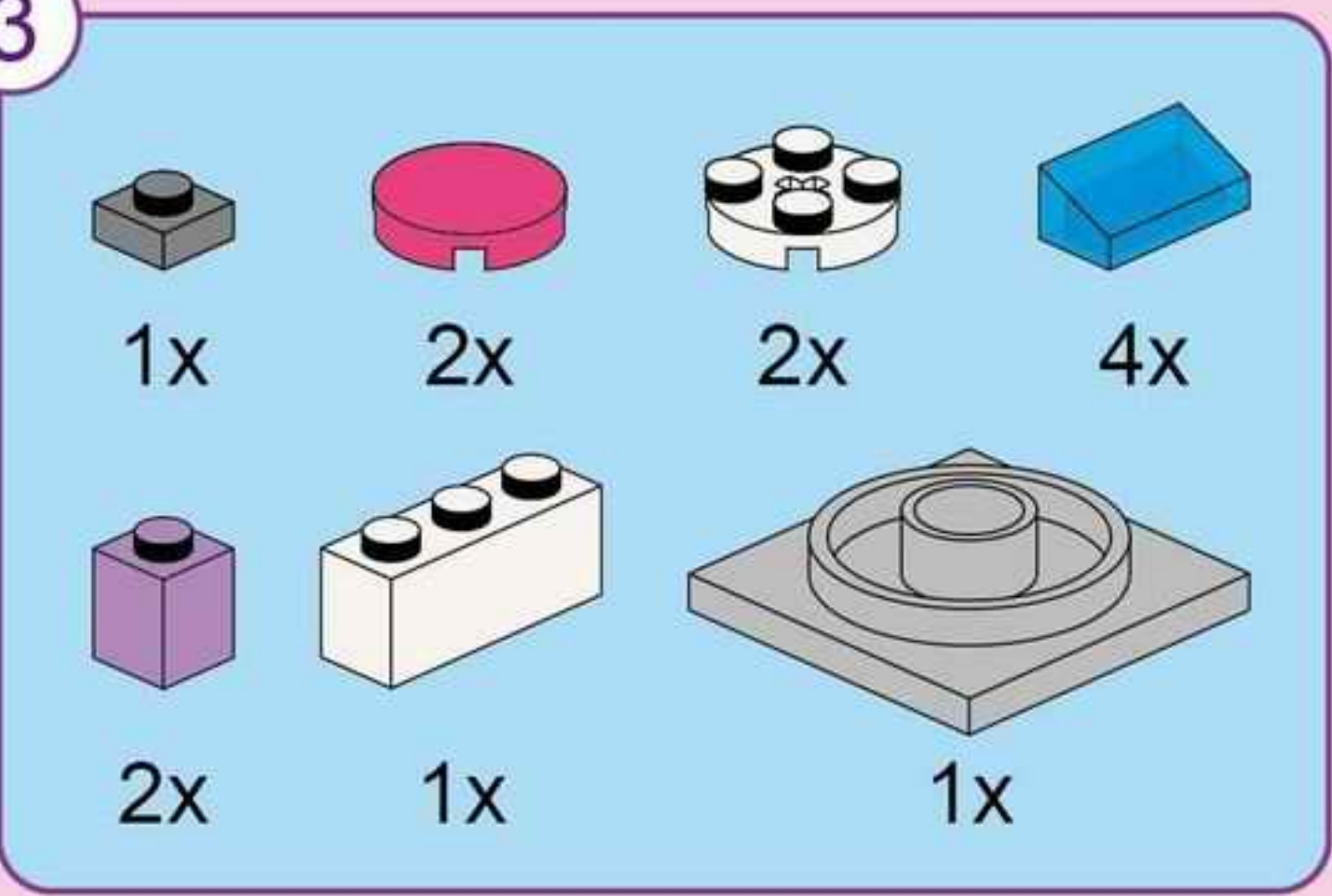

4

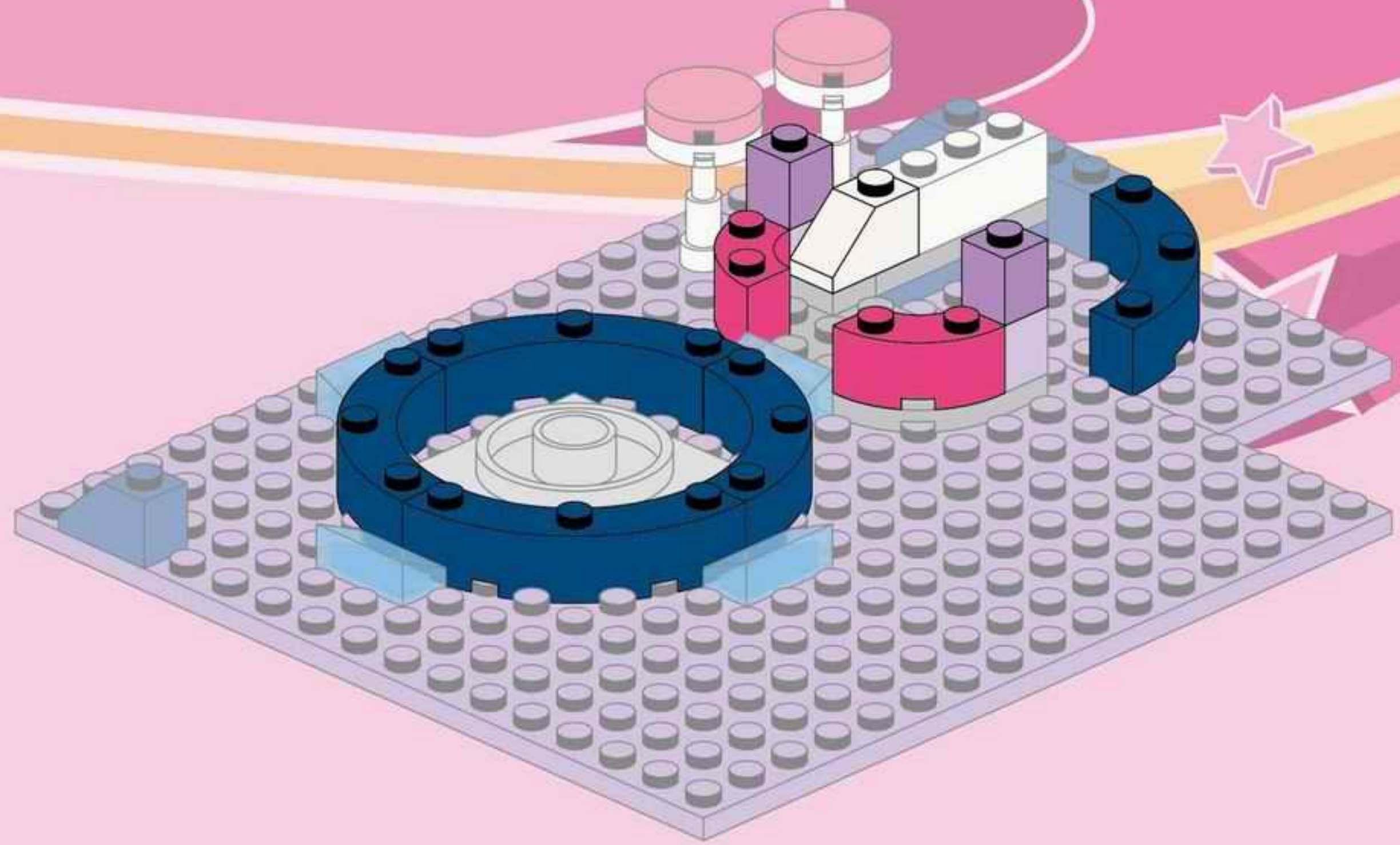
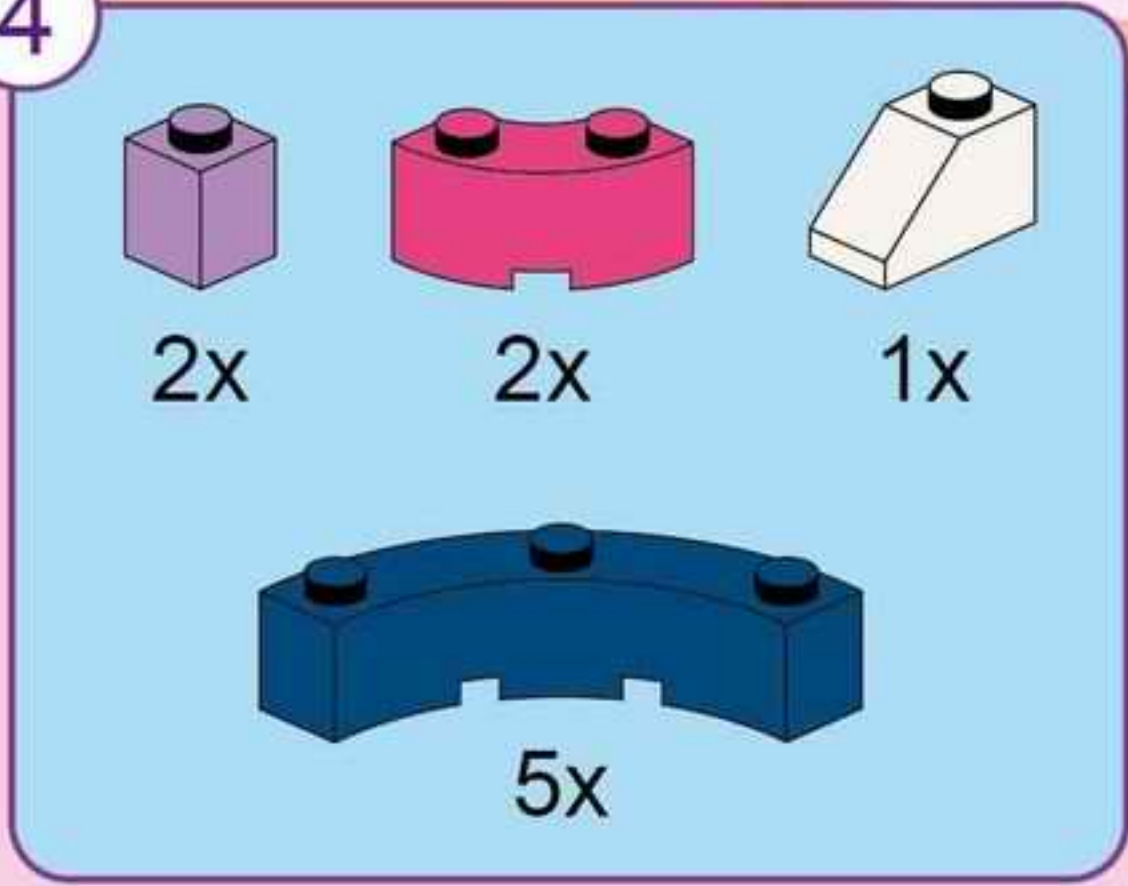

5

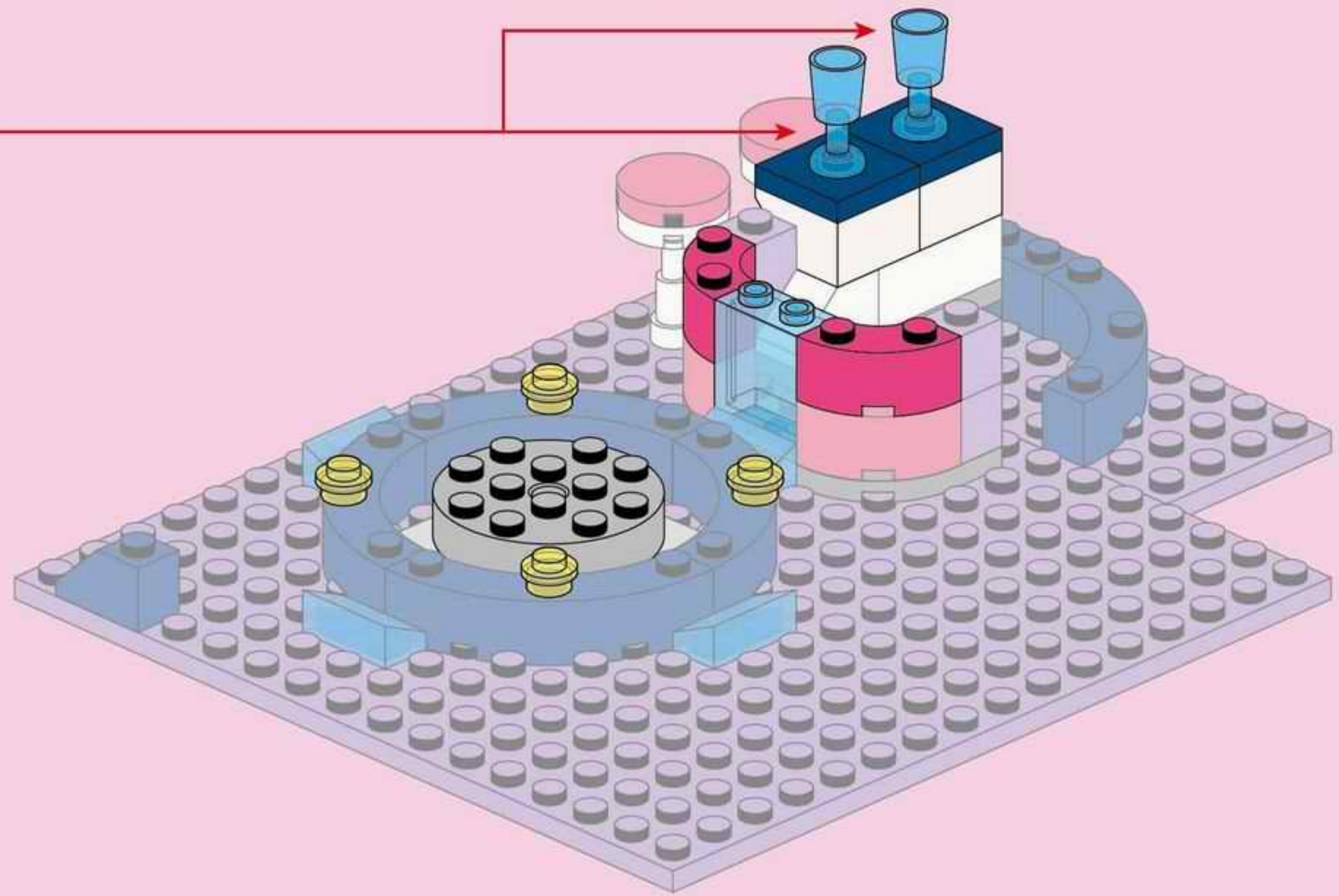
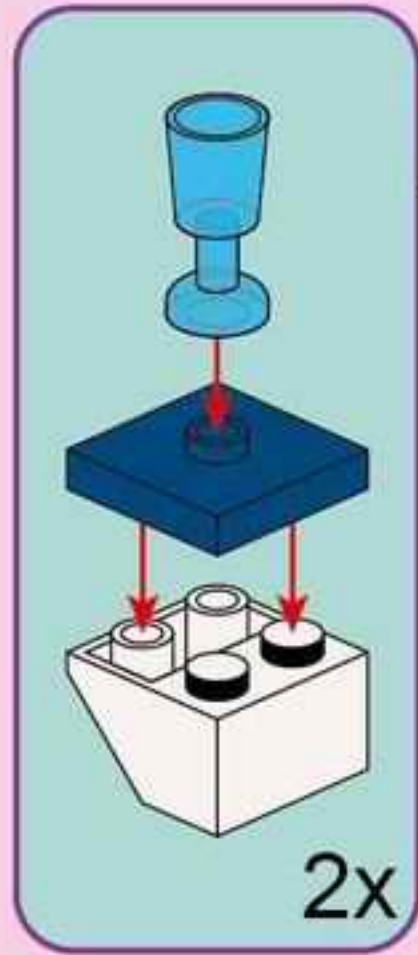
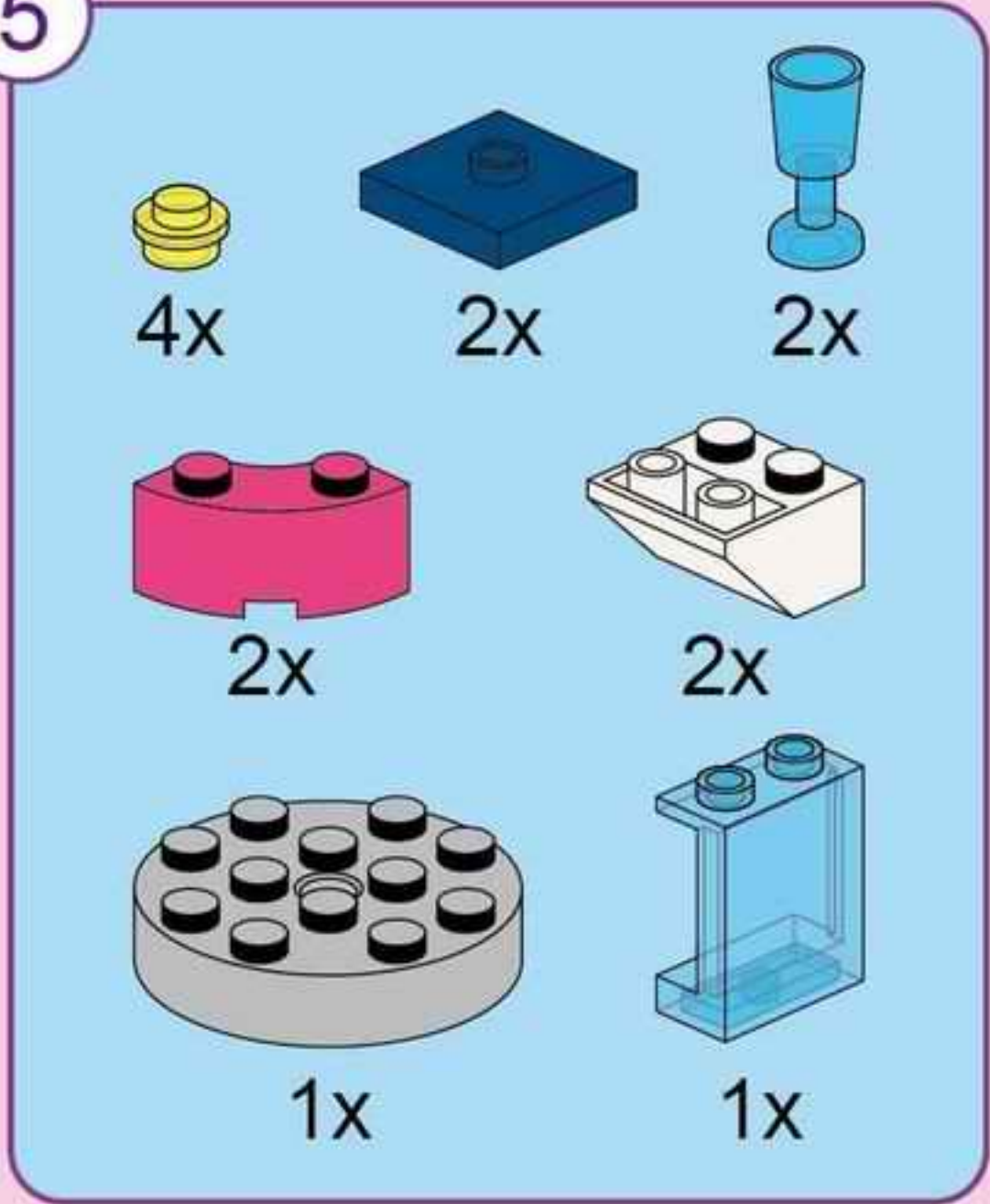

6

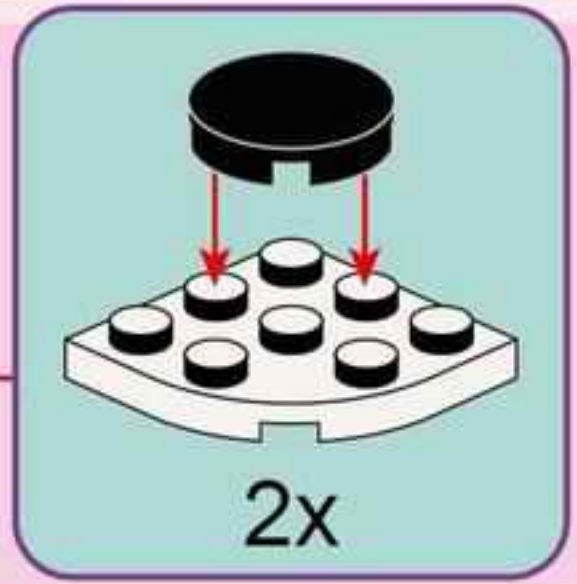
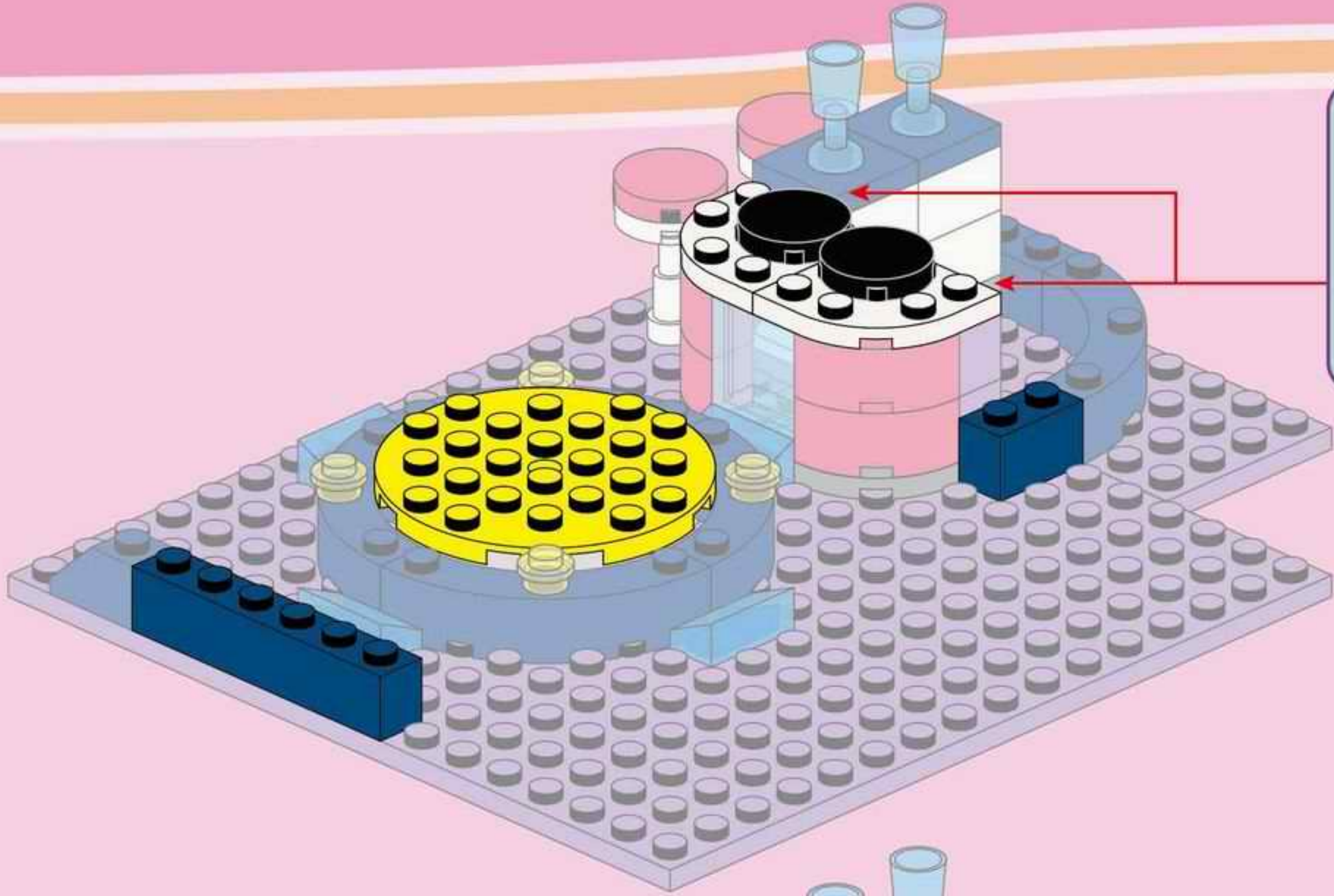
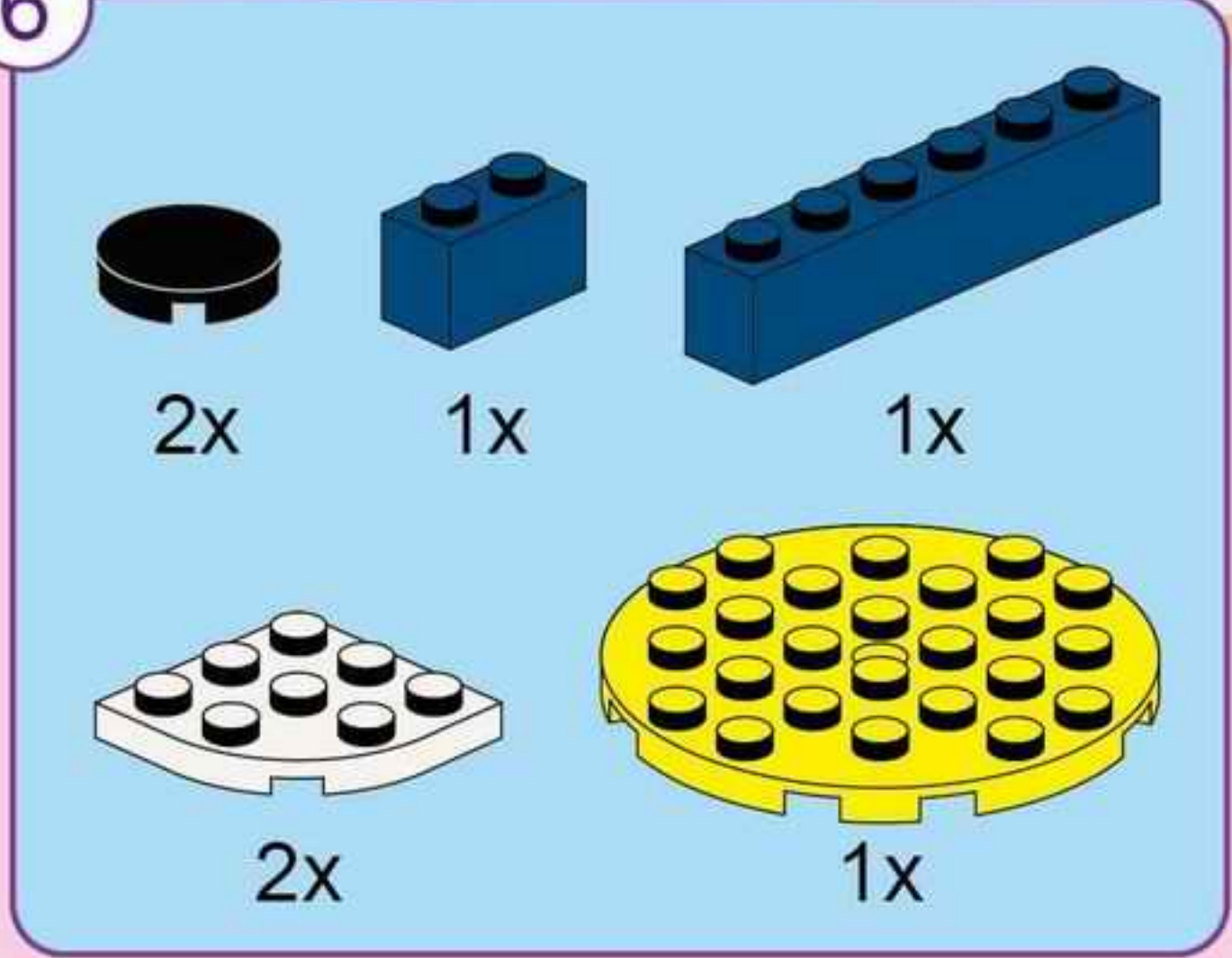

7

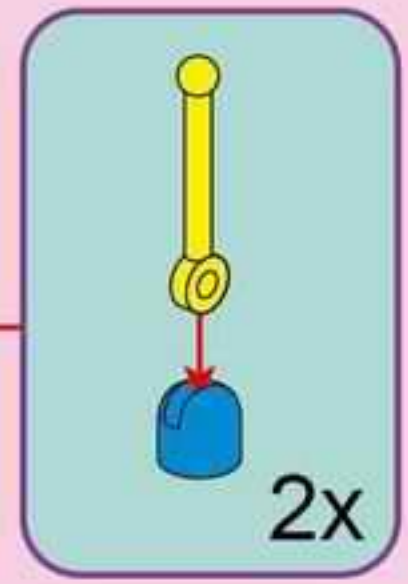
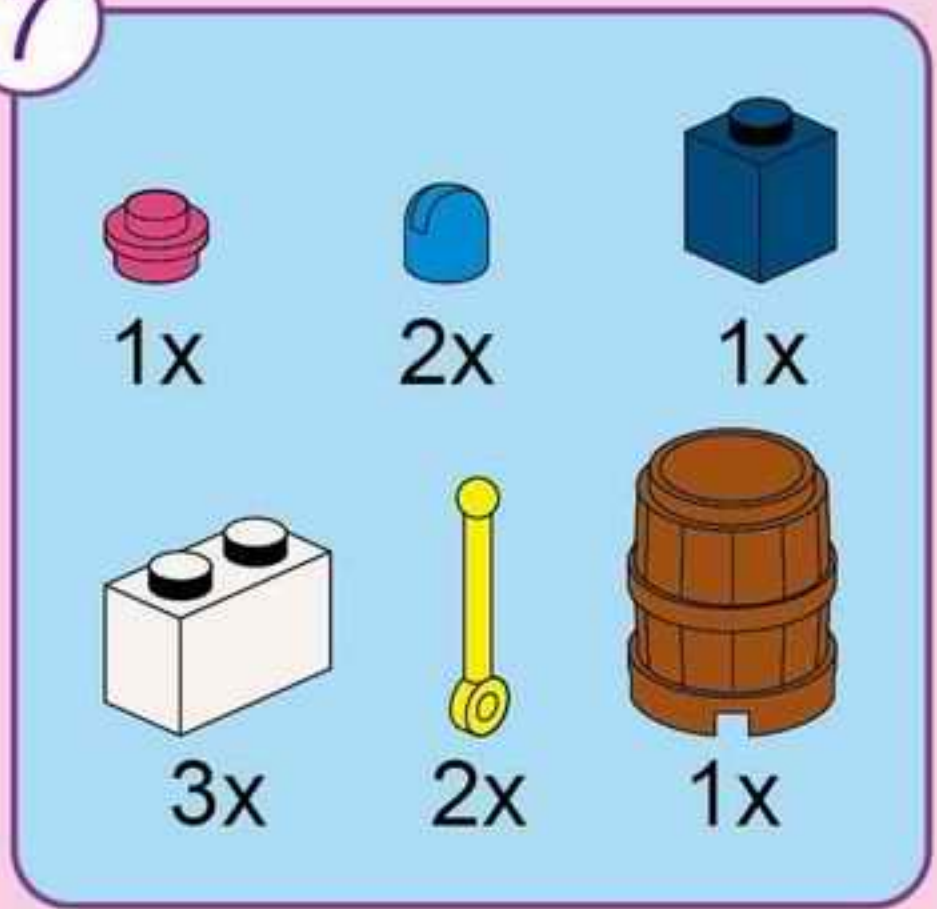

8

4x 1x 2x 1x



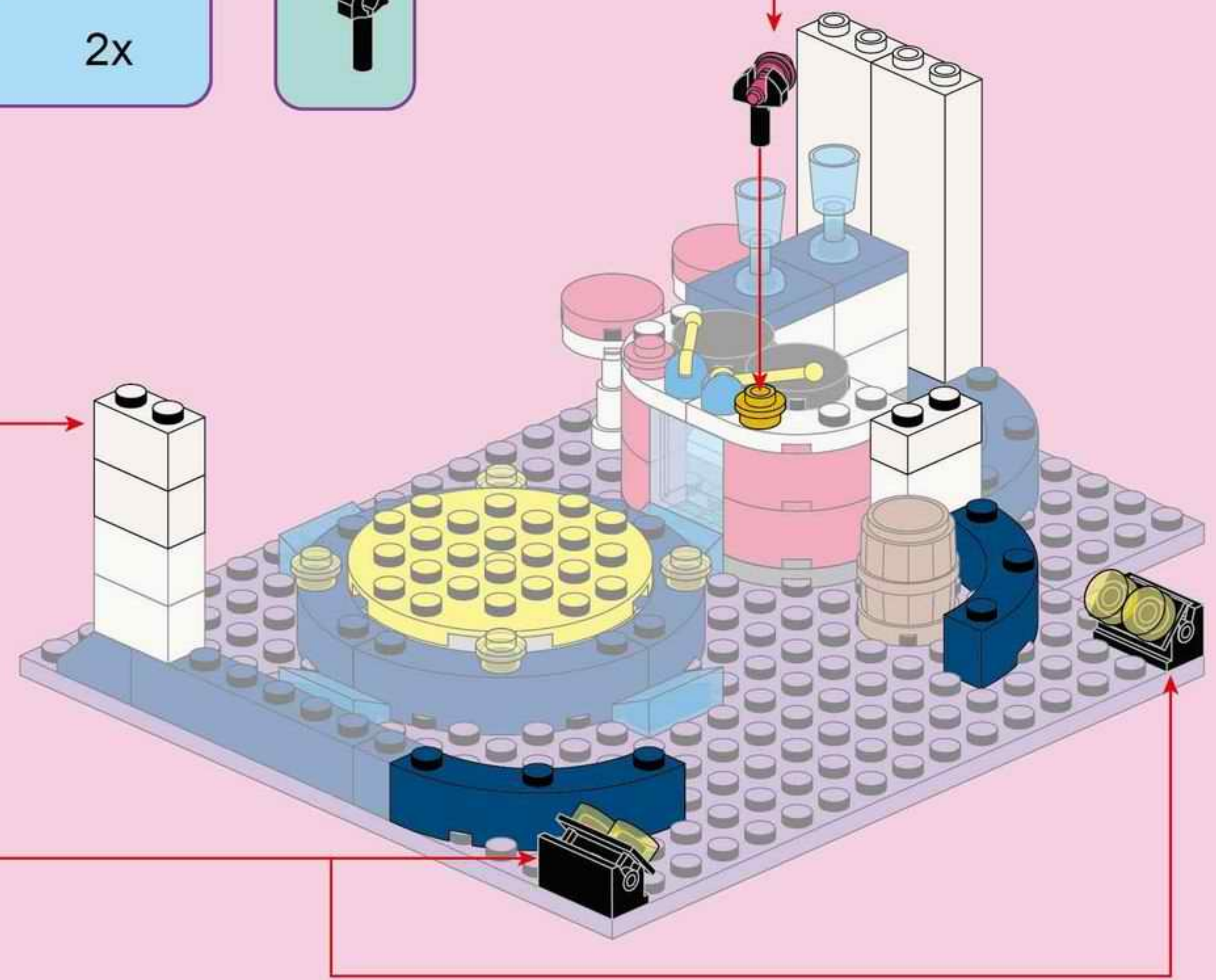
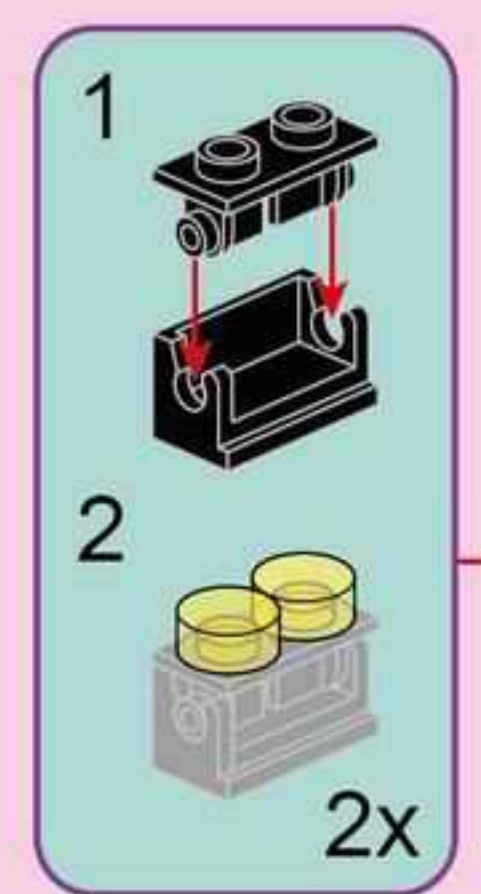
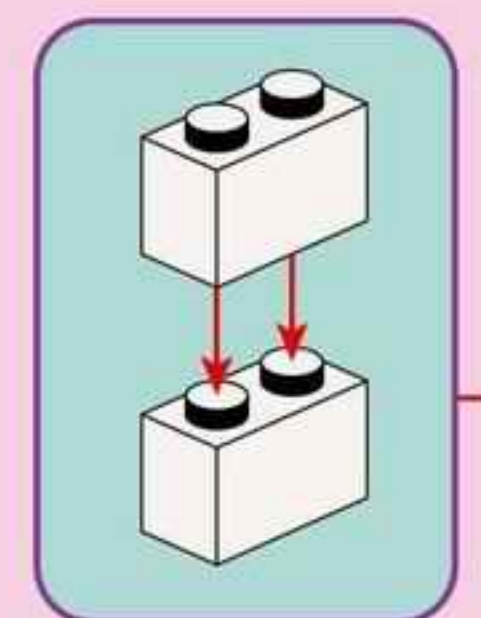
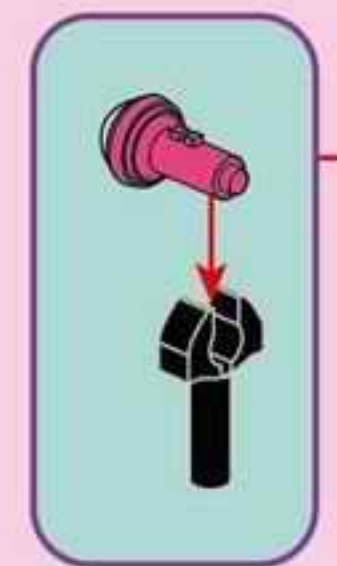



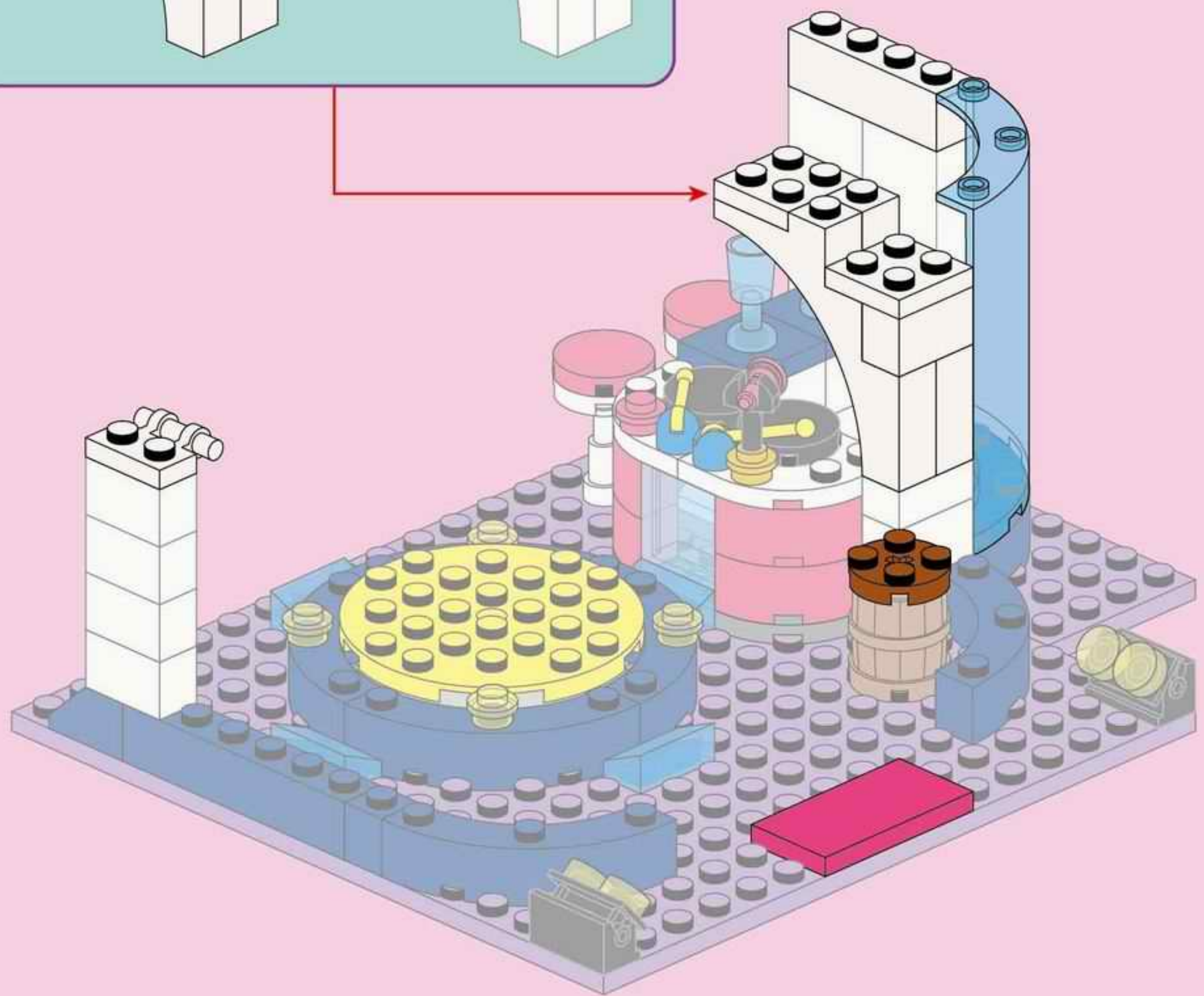
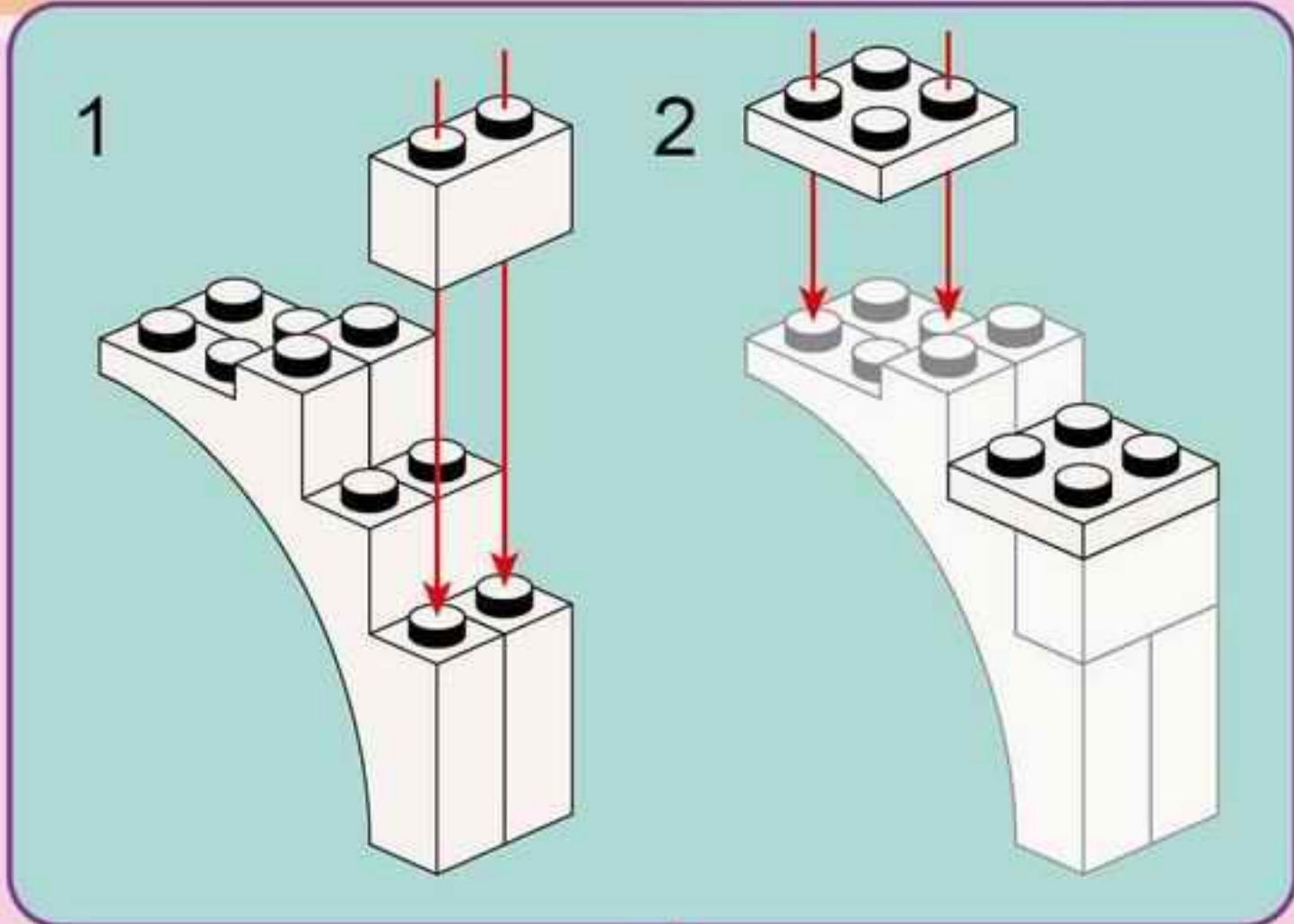
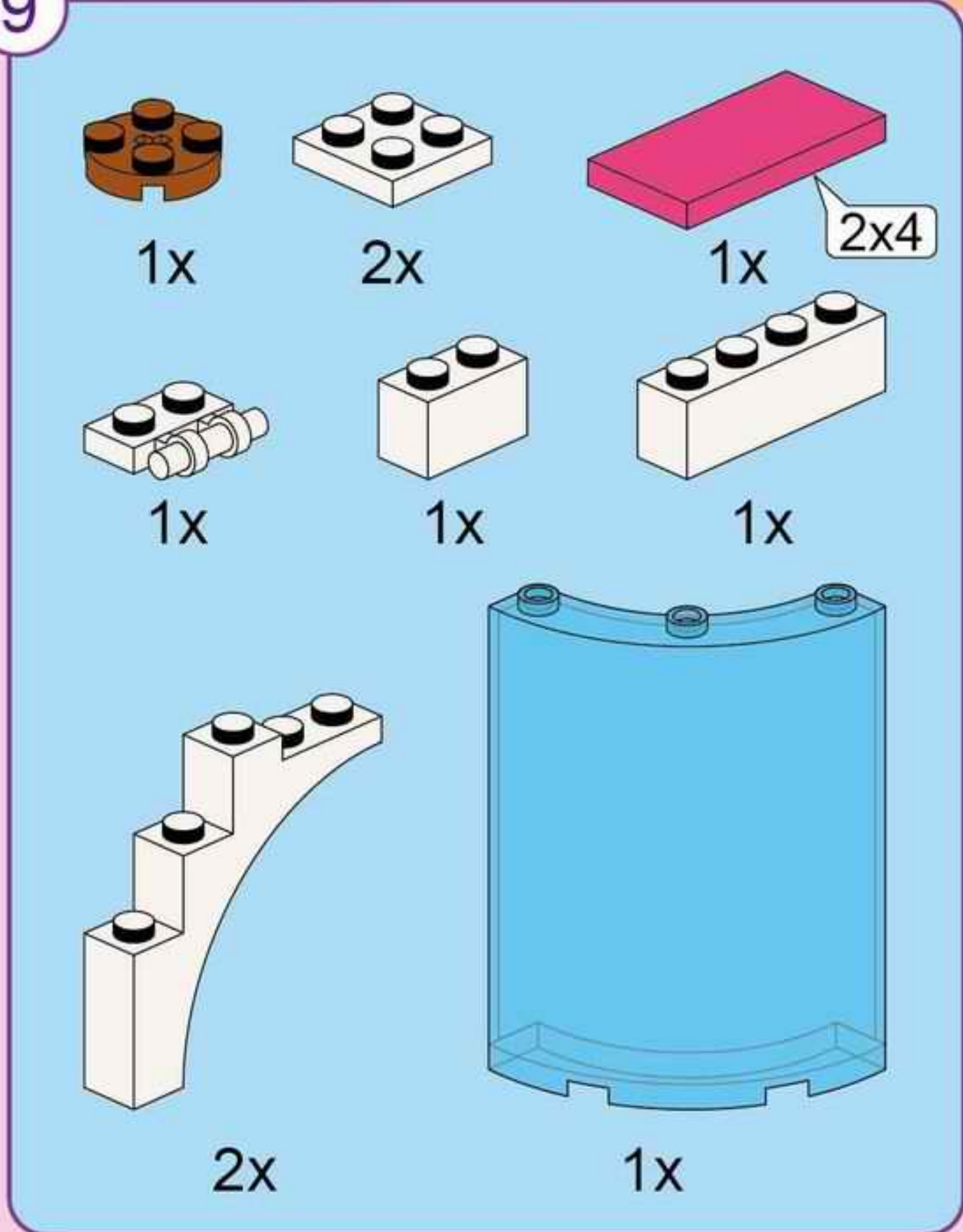

1x 1x 2x 2x 2x 2x



9



10

			
1x	2x	1x	1x
			
2x	2x	1x	1x

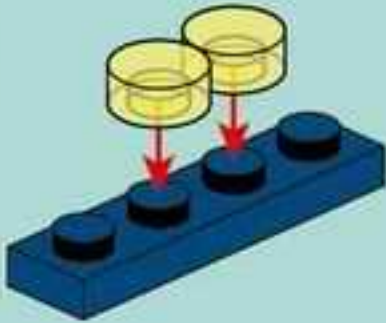
1 

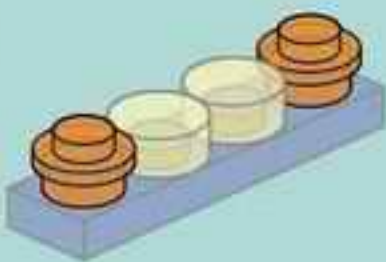
2 

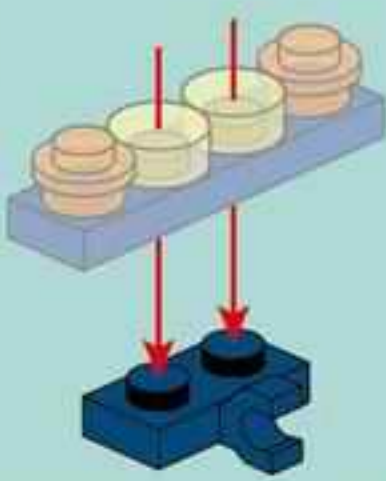
3 

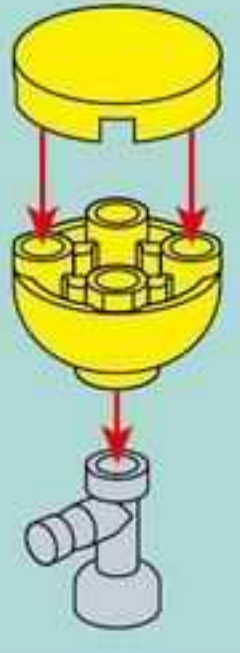
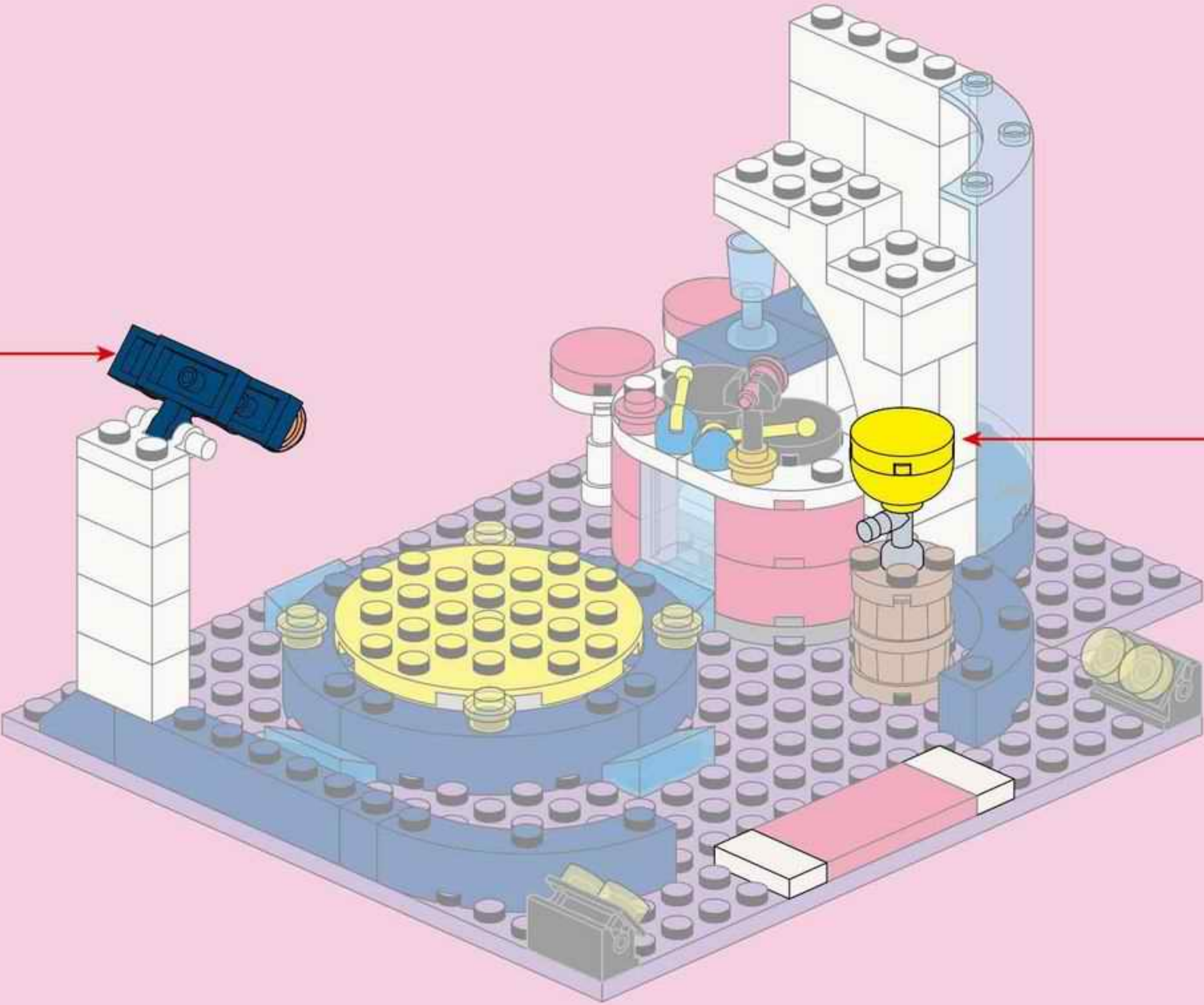



11

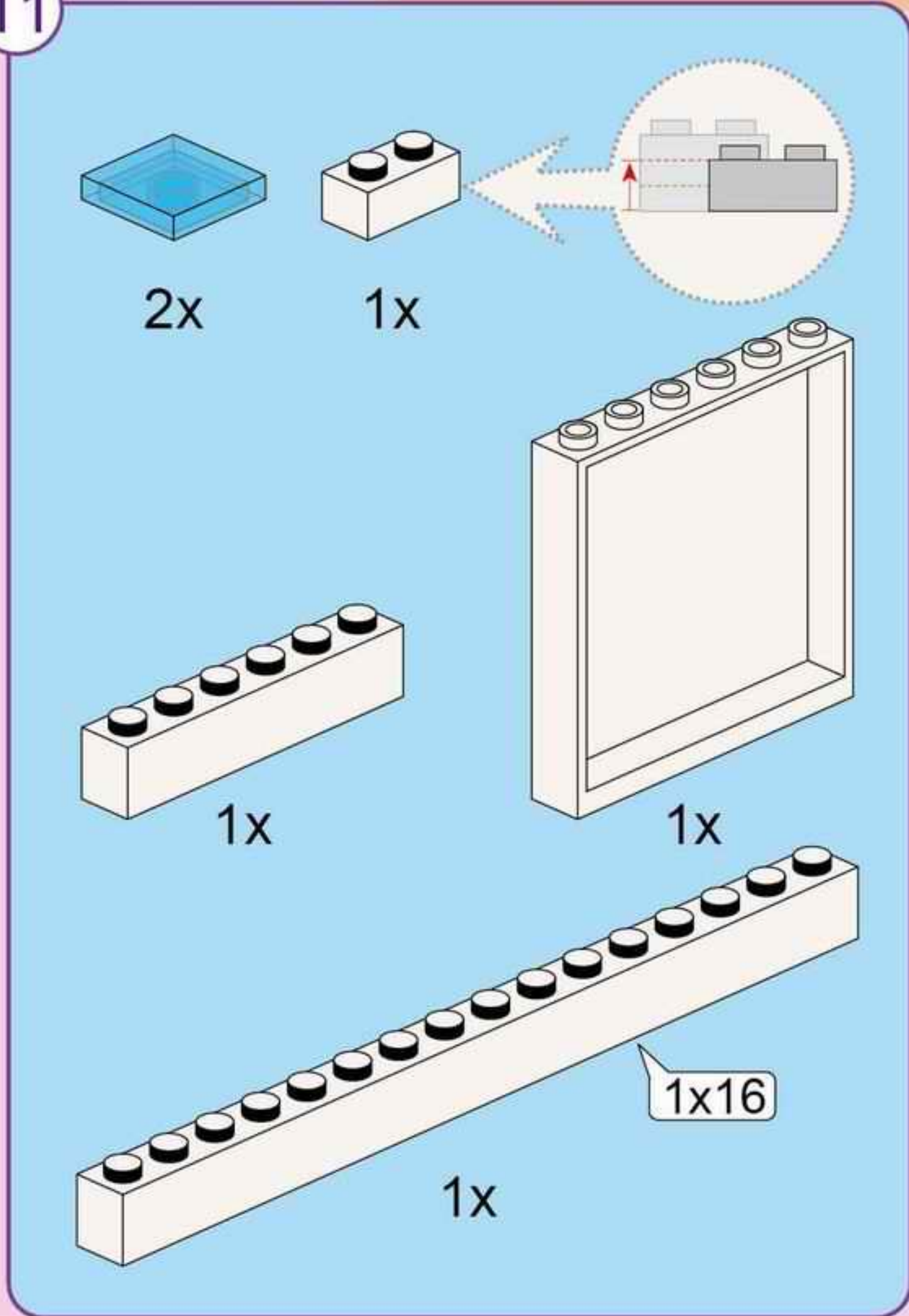



+

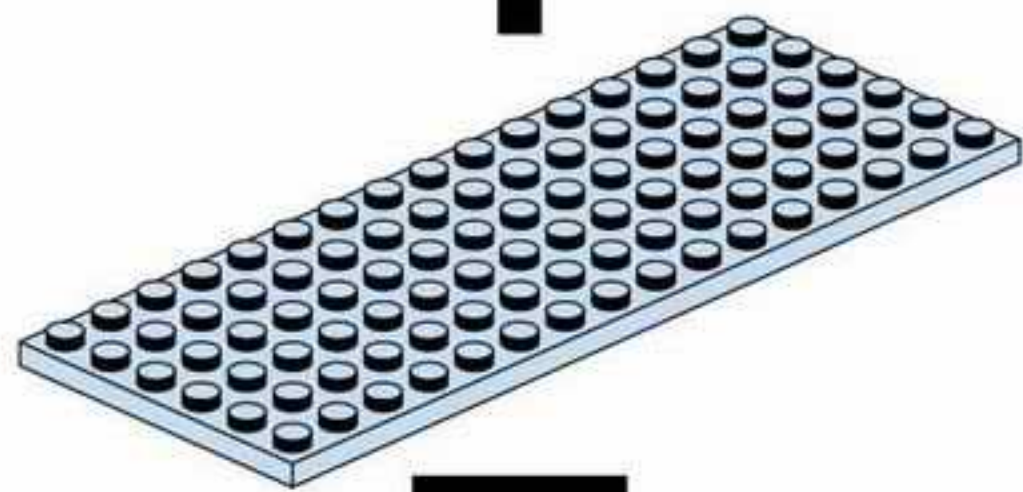

=

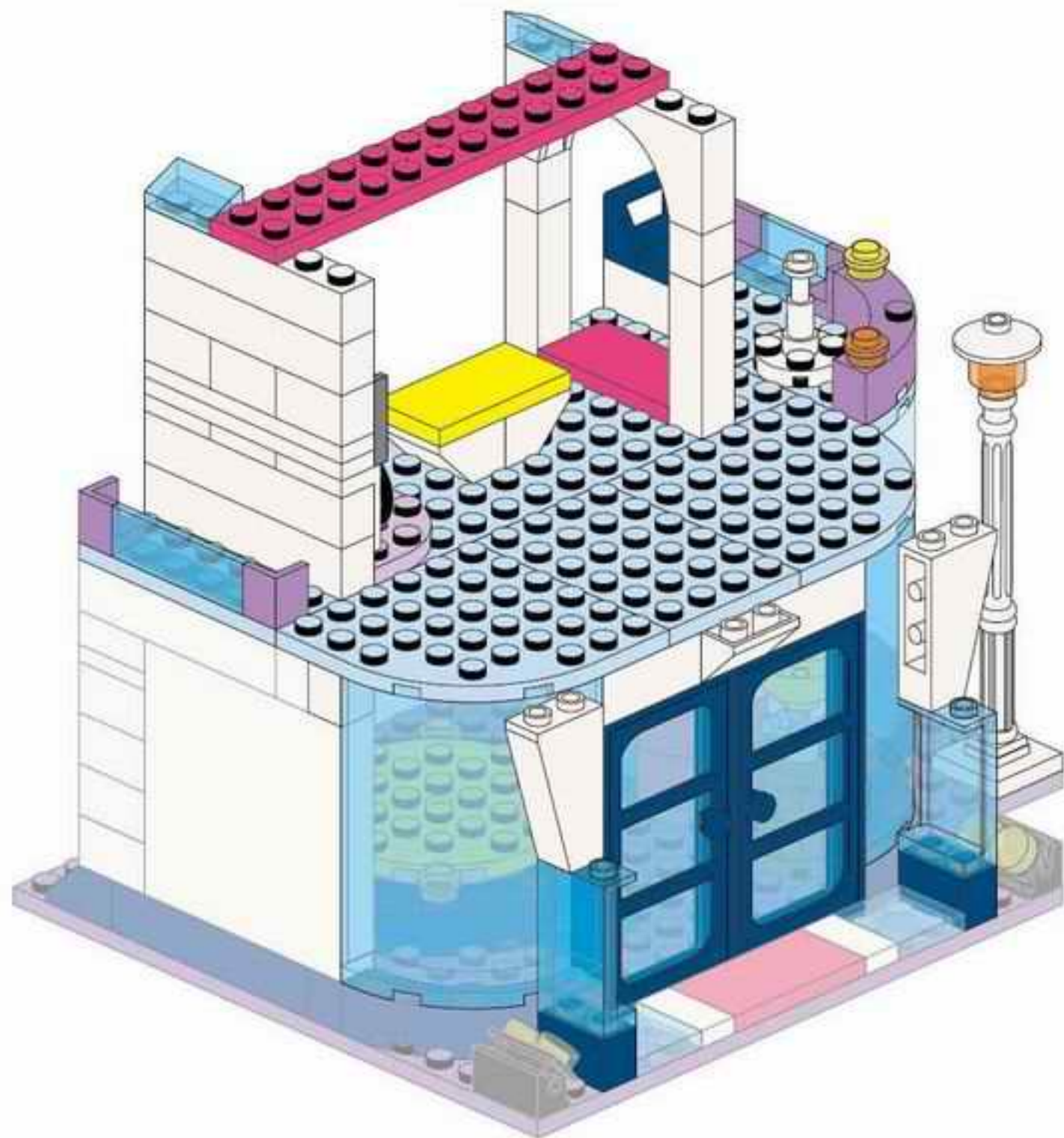

12

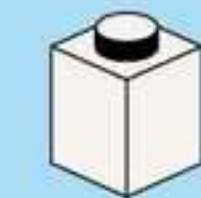

1x

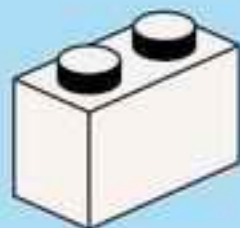

1x



2x

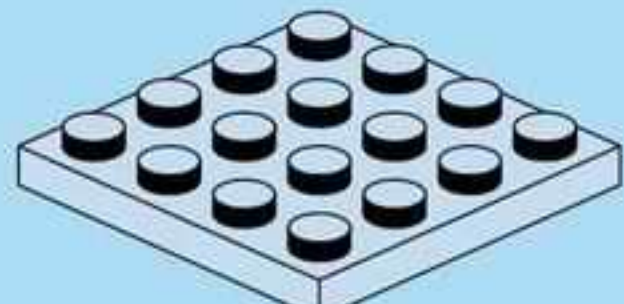

1x



1x

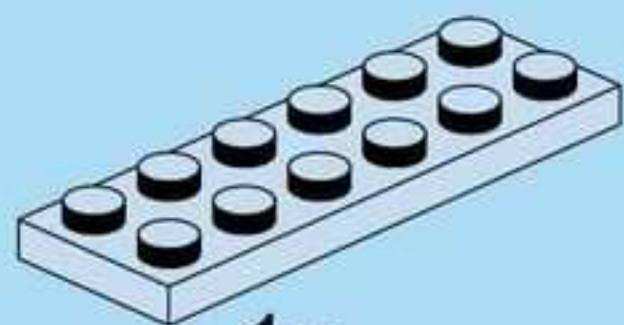

1x

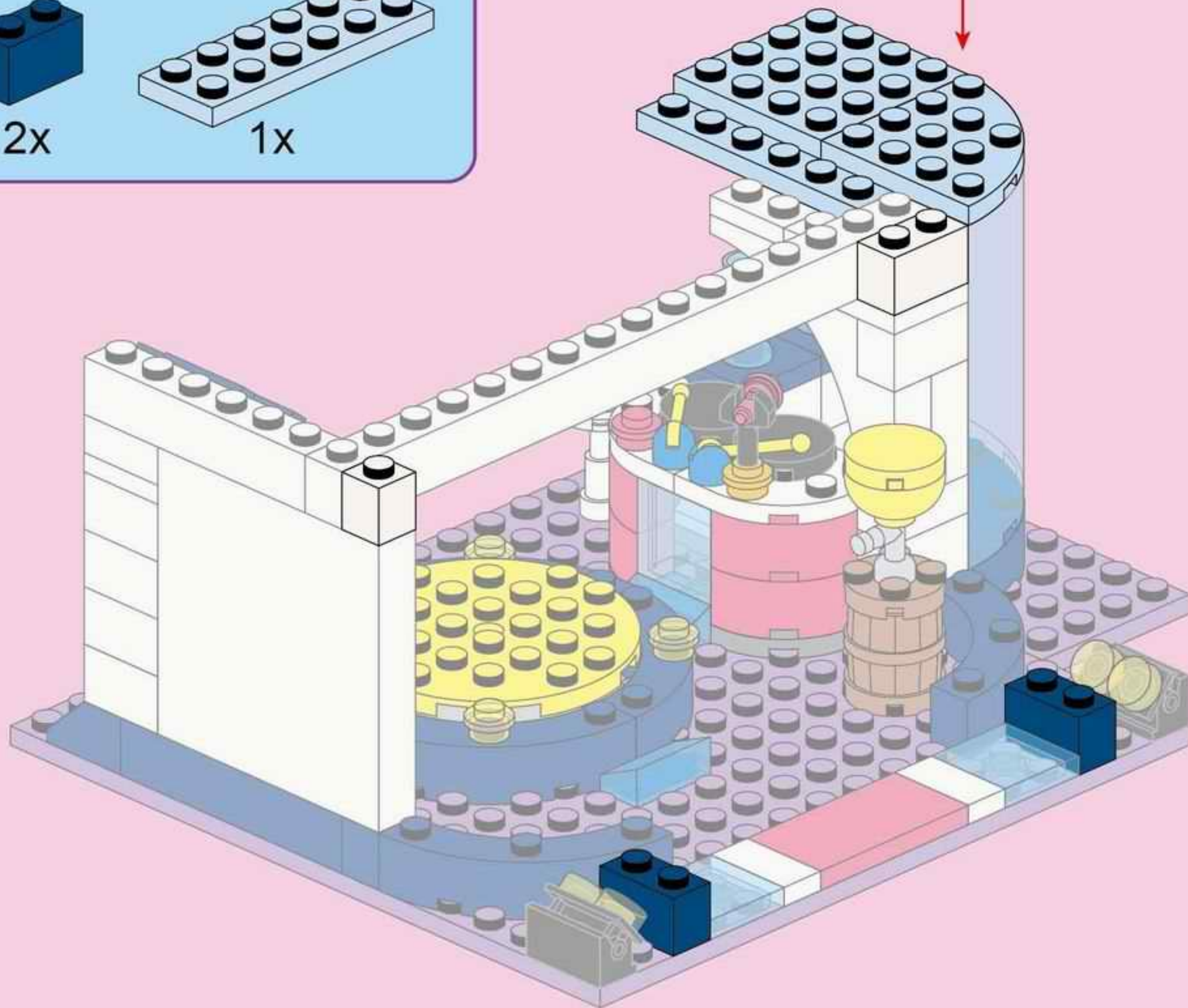
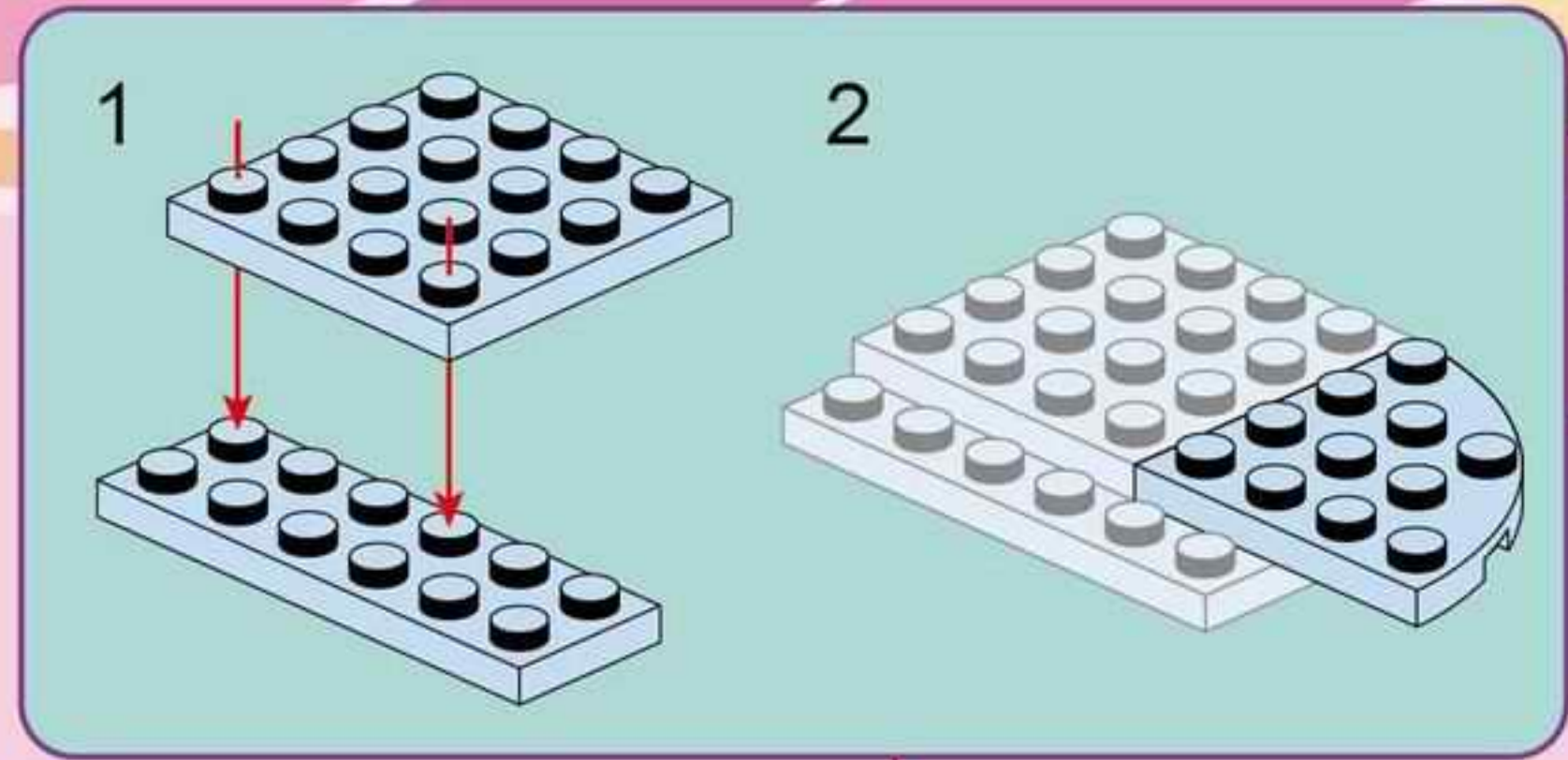

13

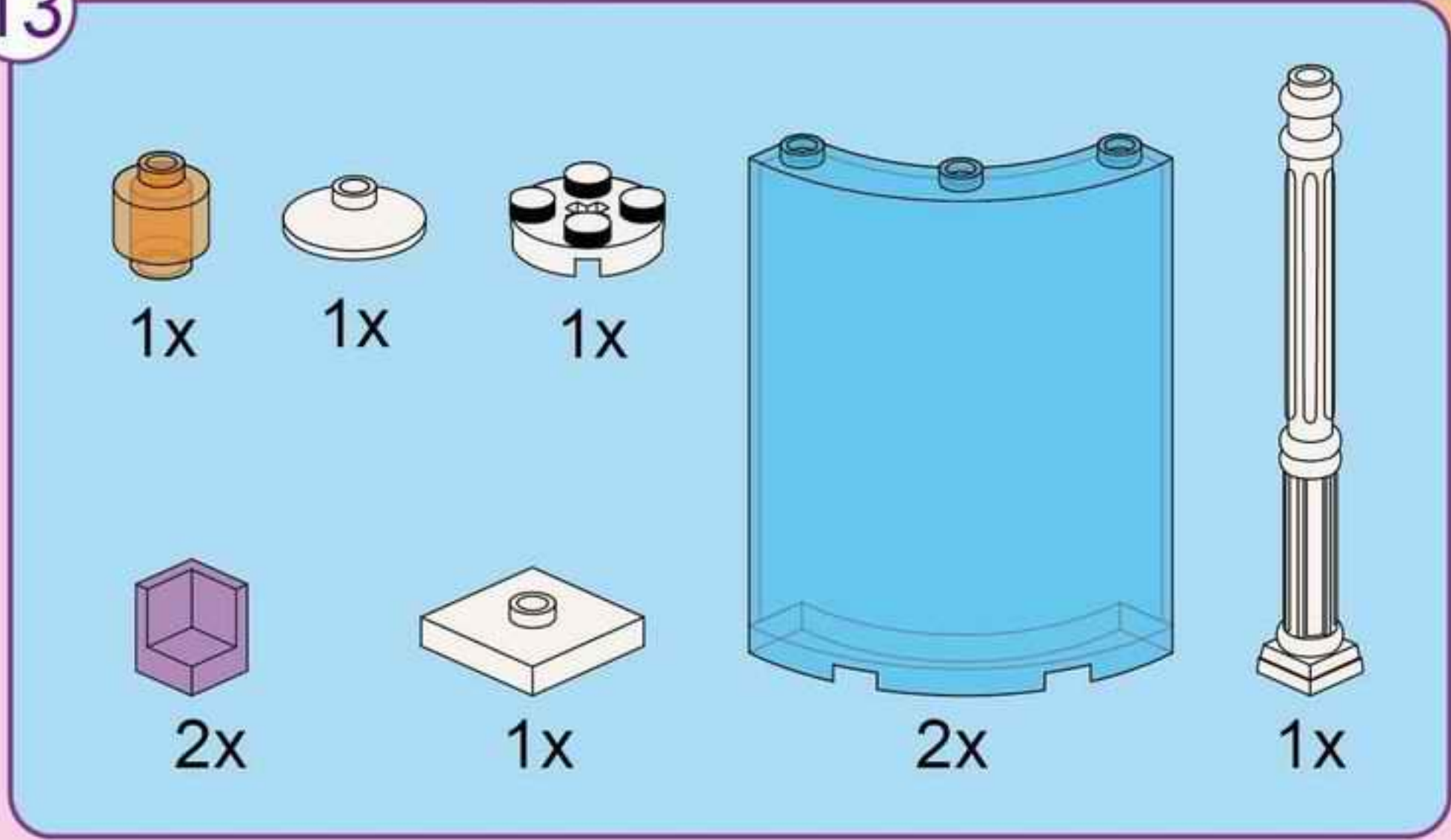

1x  
1x  
1x  
2x  
1x  
2x  
1x

This block contains a list of parts for step 13. The parts are: 1x orange axle, 1x white axle, 1x black axle, 2x purple axle, 1x white axle, 2x blue curved wall, and 1x white axle.

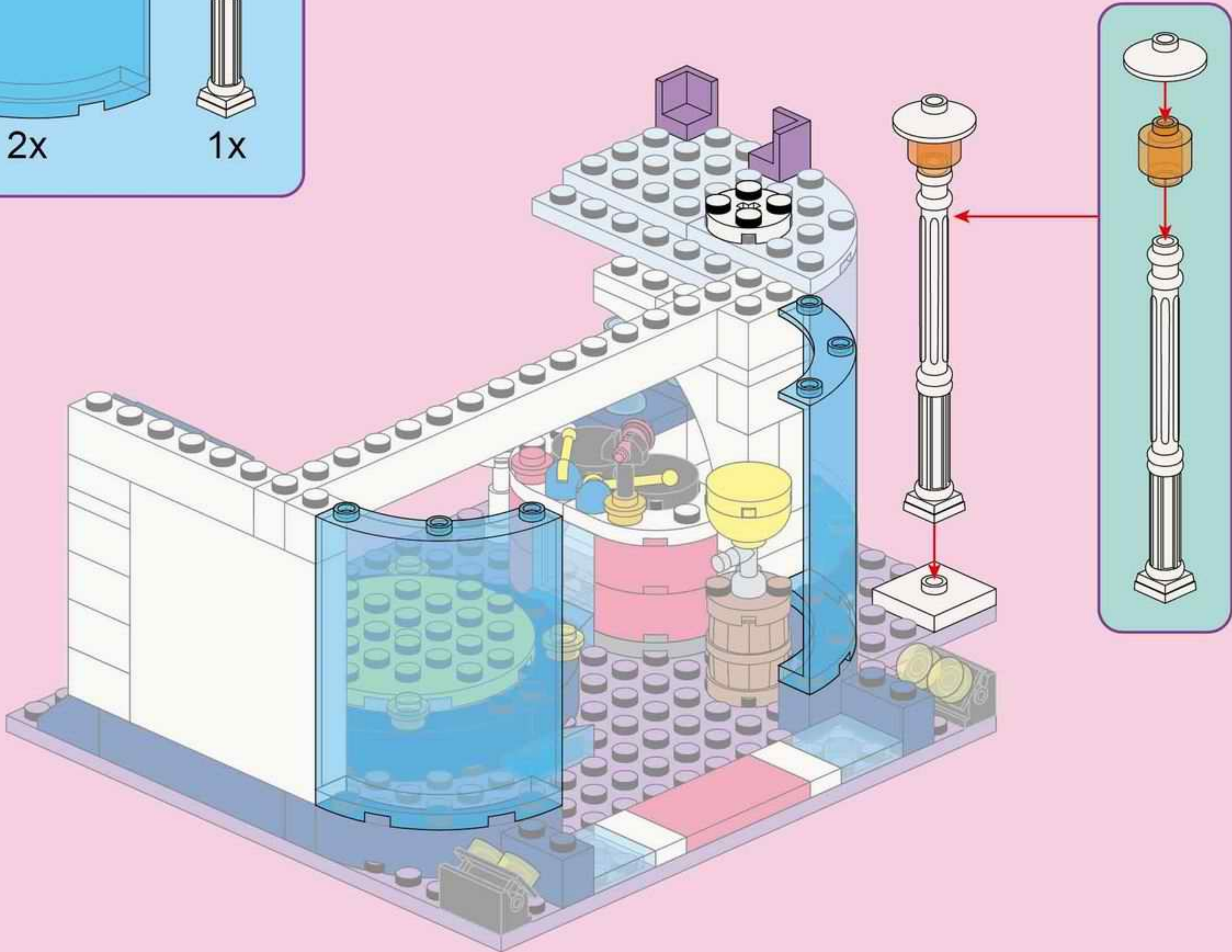

14

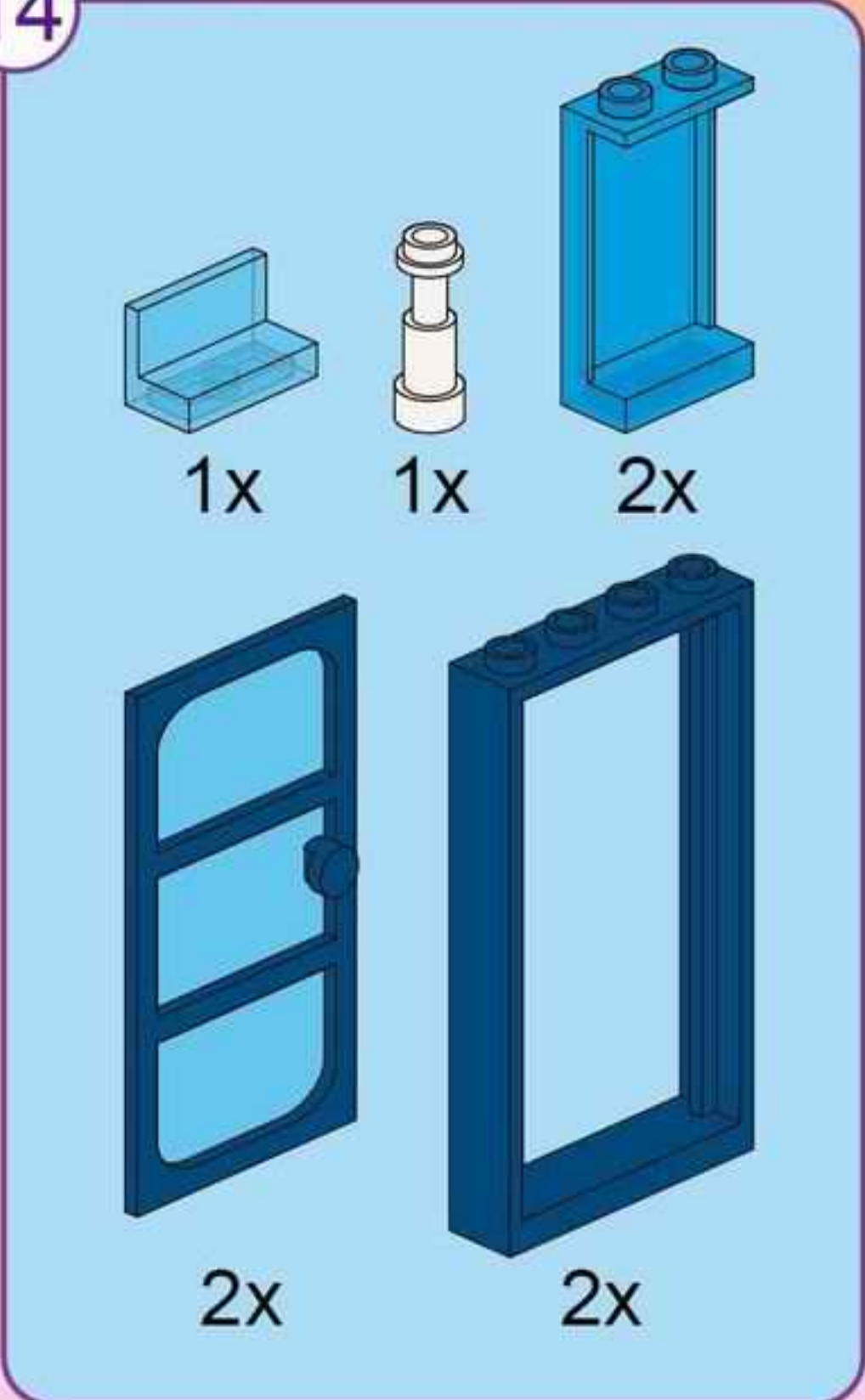

1x  
1x  
2x  
2x  
2x

This block lists the required parts for step 14: one light blue 1x2 Technic shelf, one white axle pin, two dark blue 1x2 Technic Technic Bricks with 2 holes, two dark blue 1x2 Technic Technic Frames with 2 holes, and two dark blue 1x2 Technic Technic Frames with 2 holes.

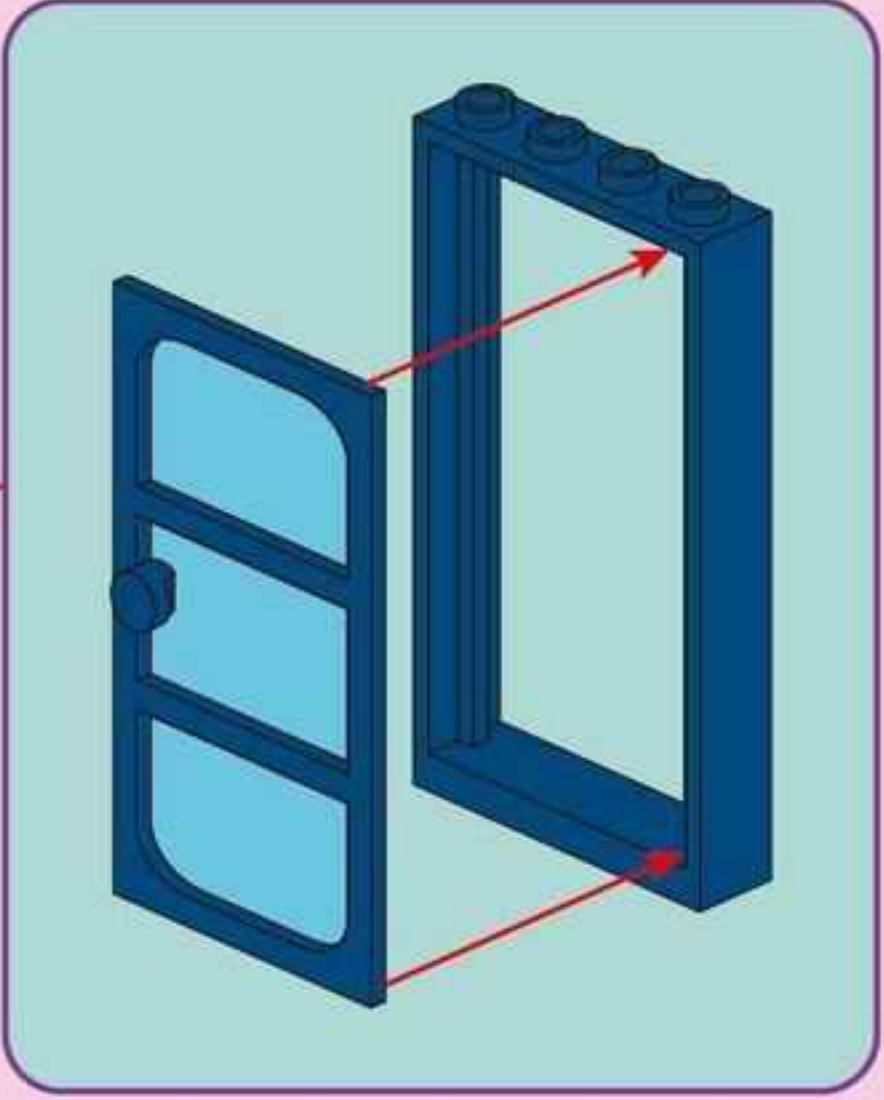
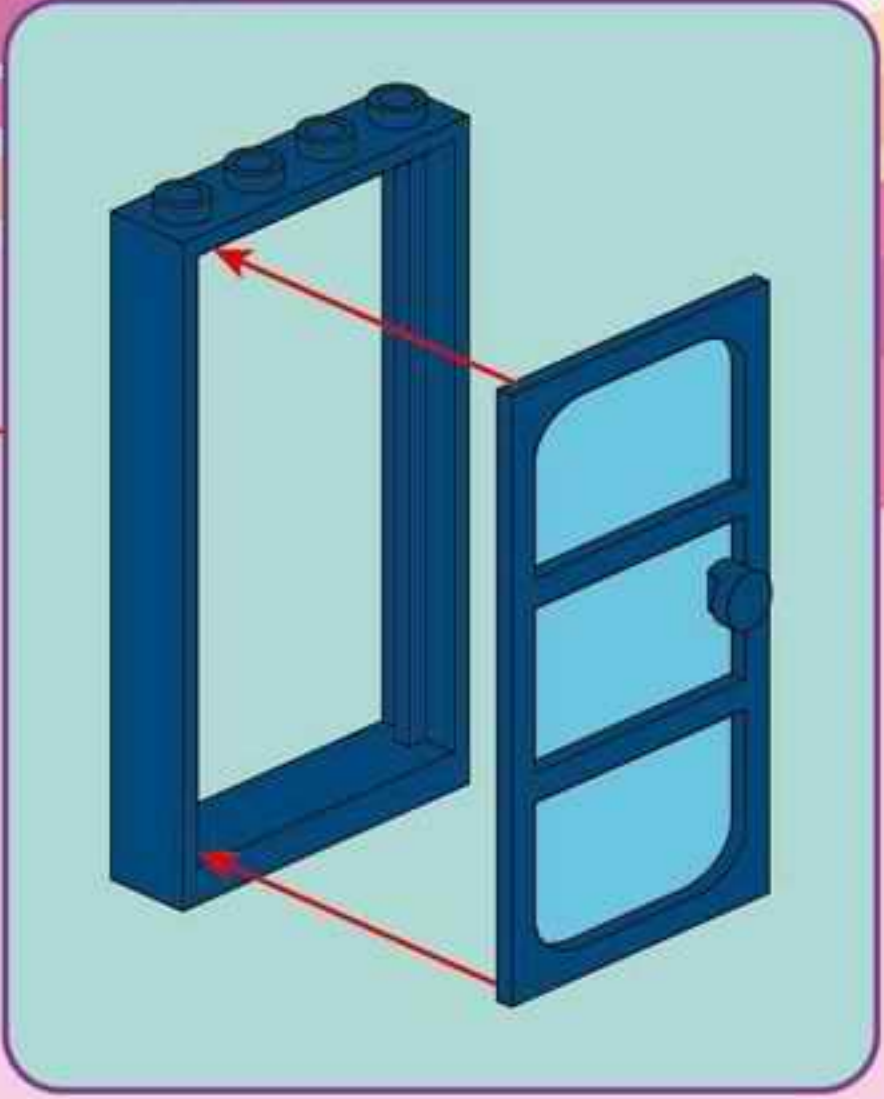
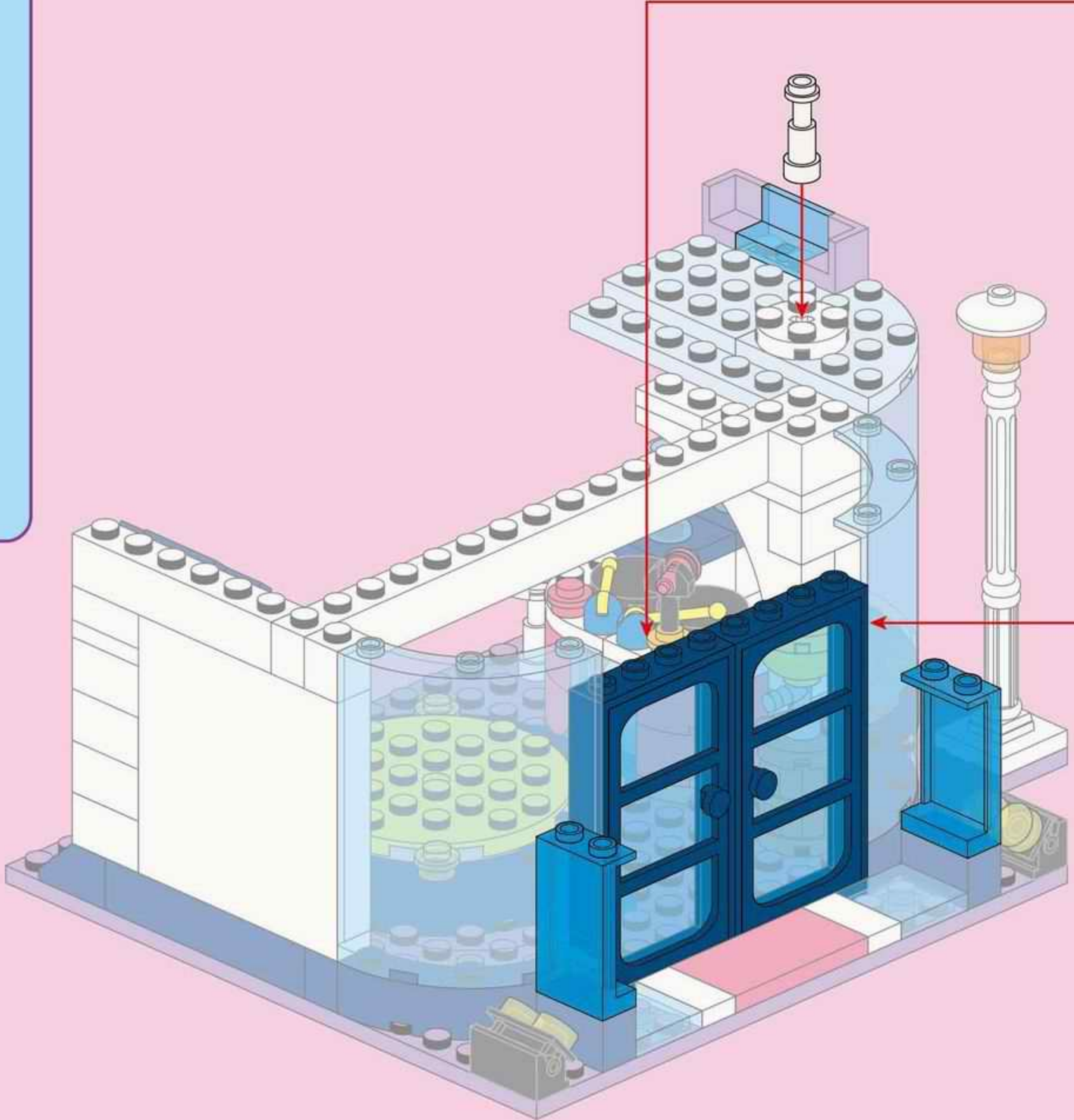

15

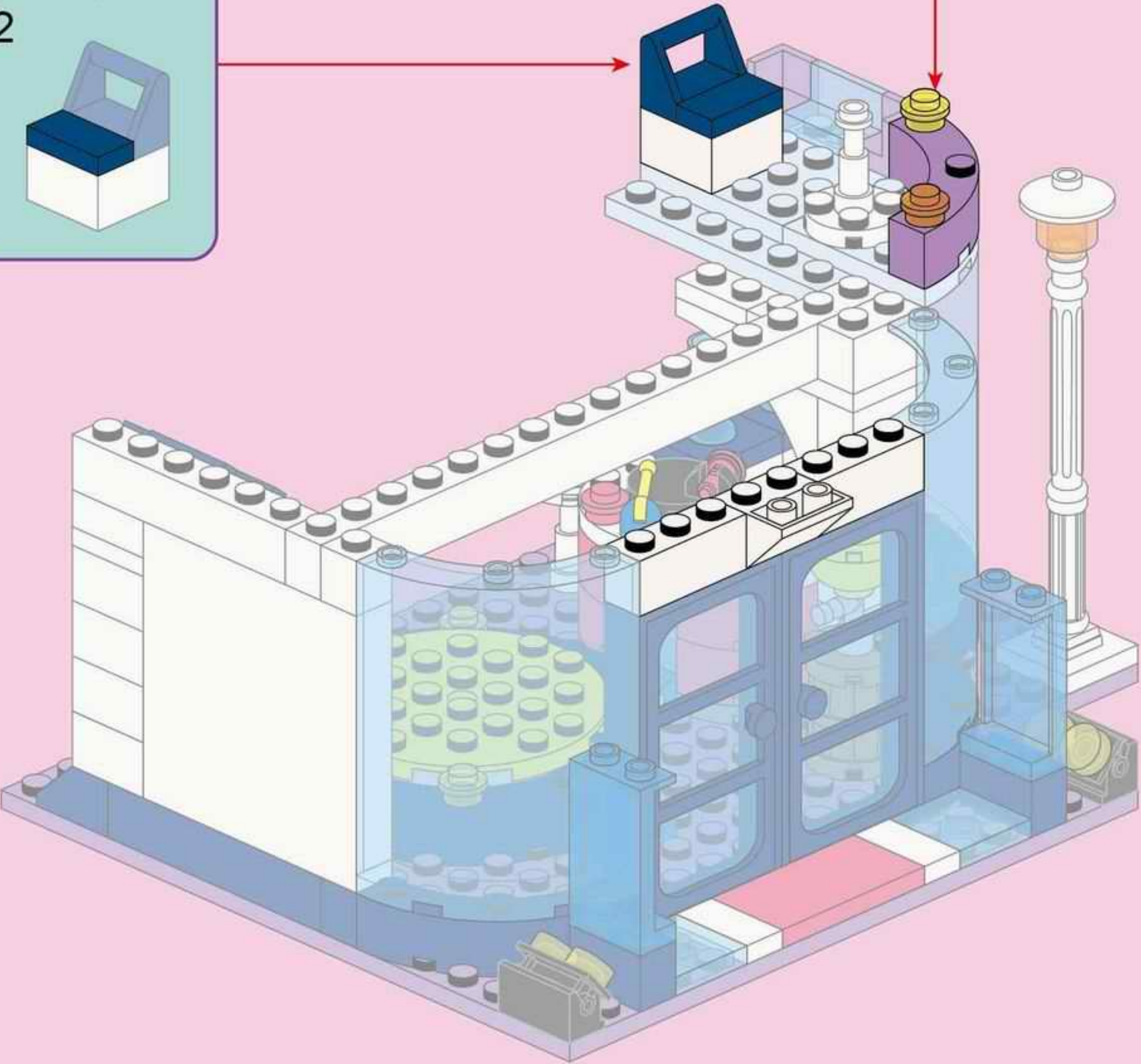
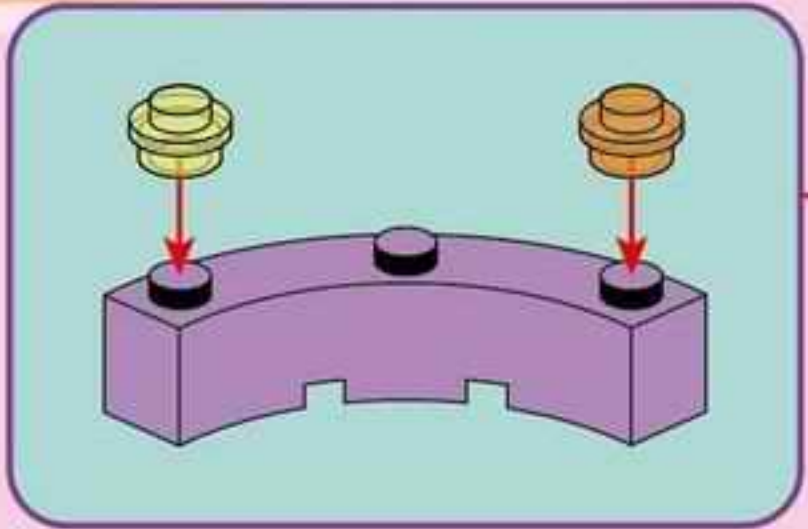
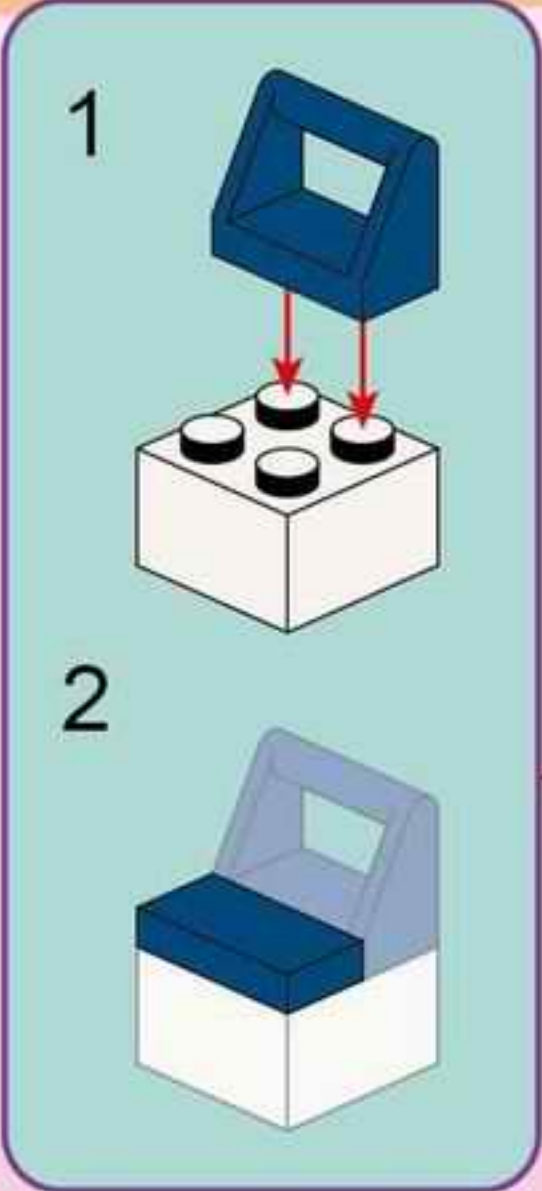
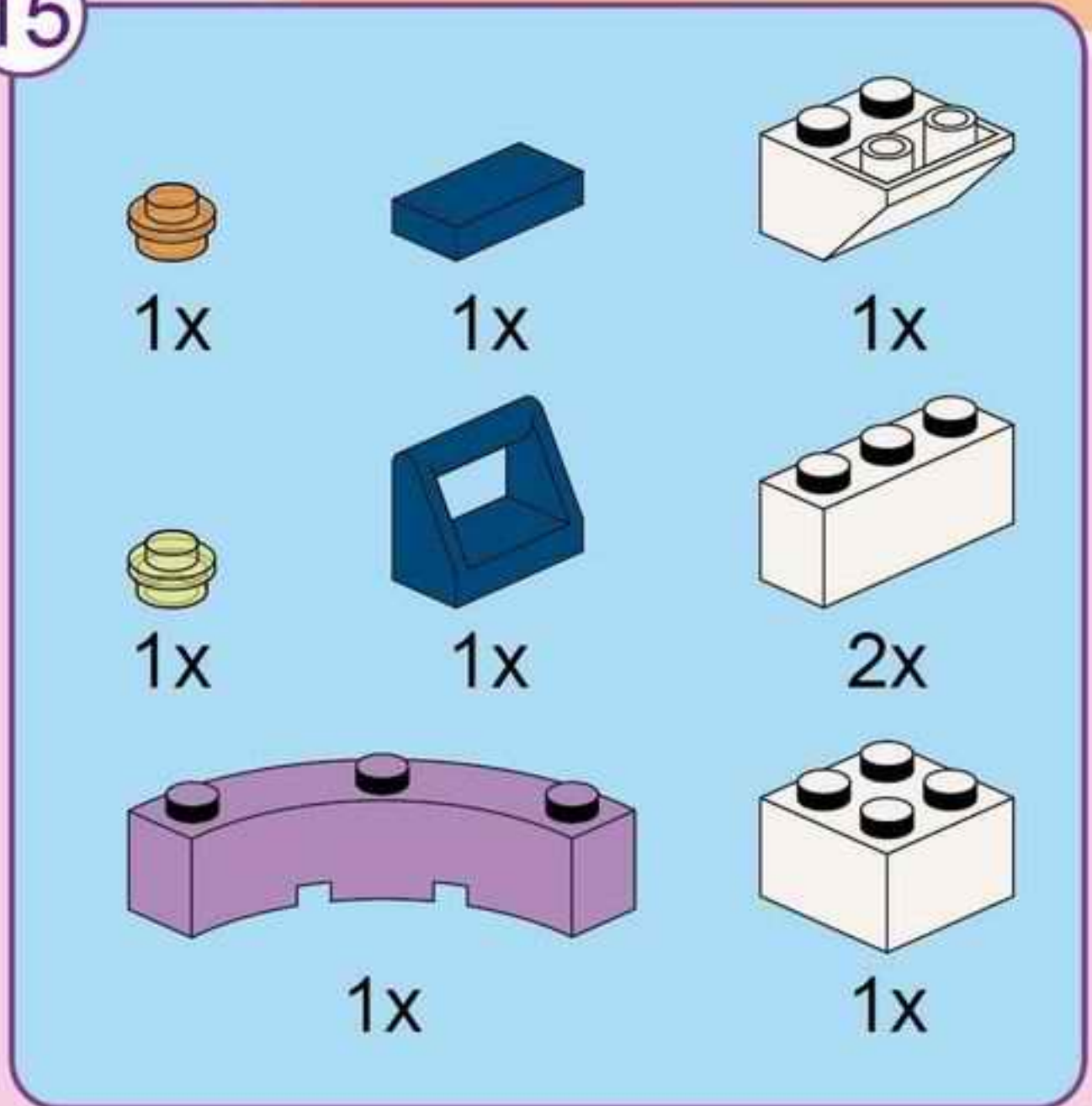

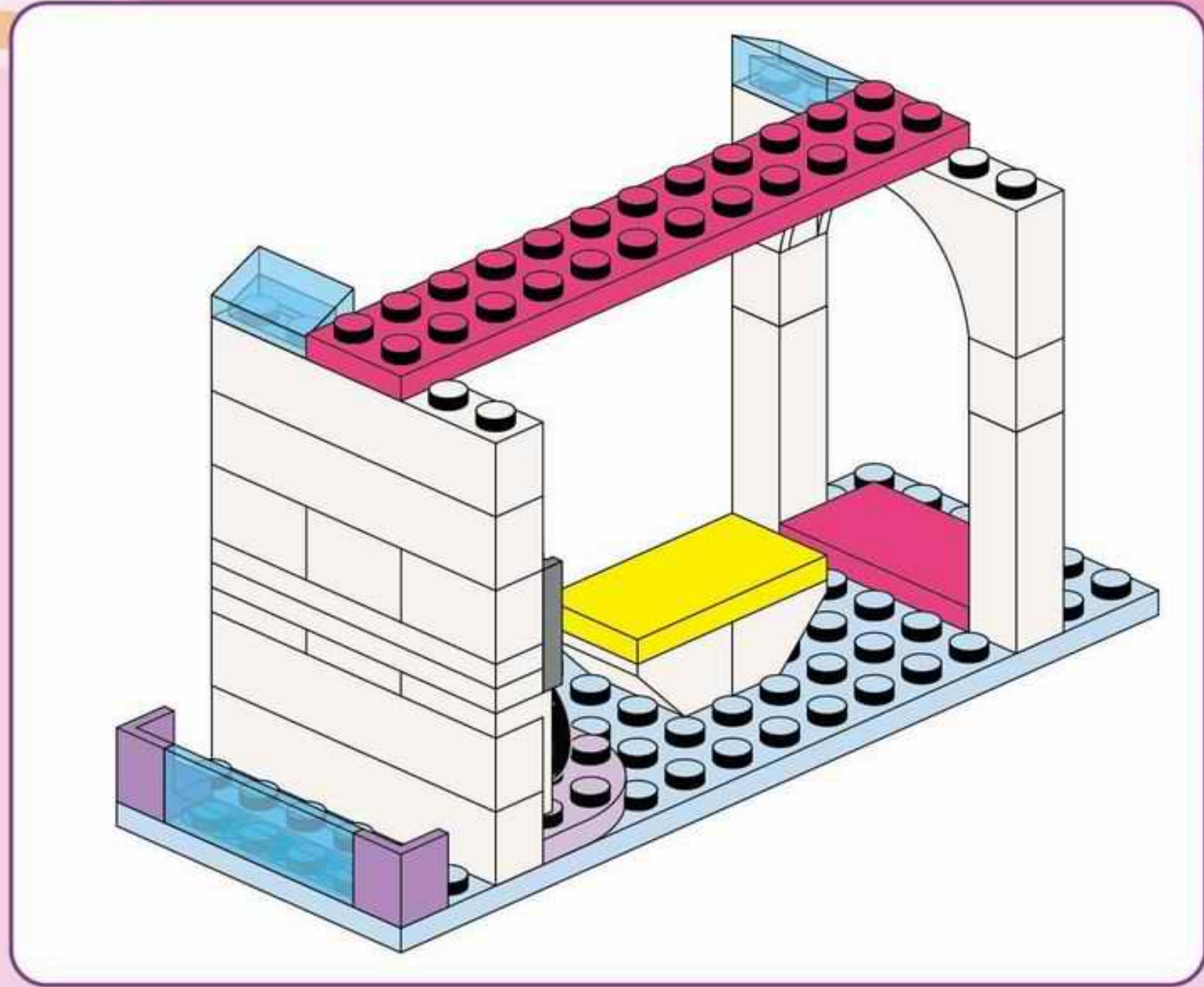

16

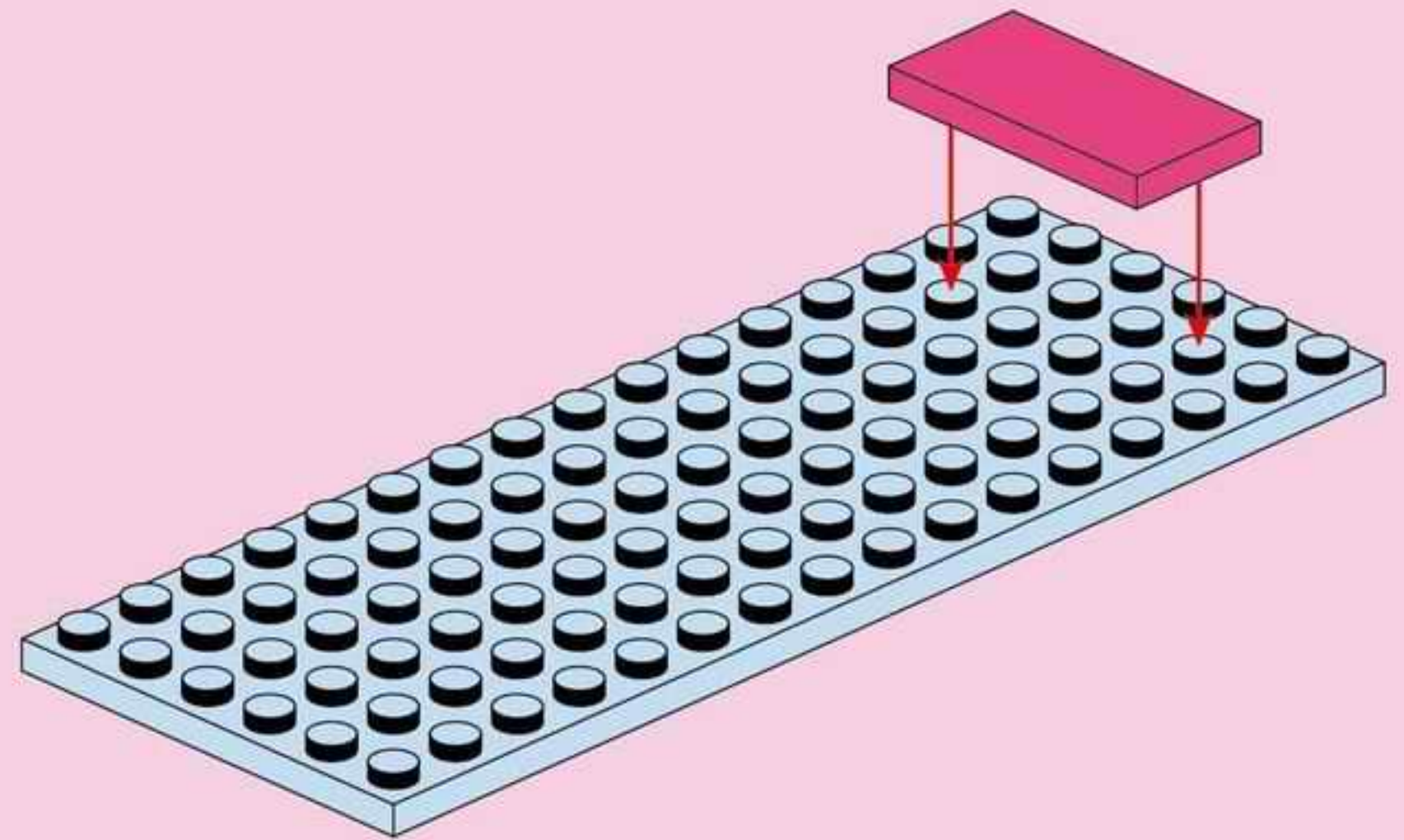
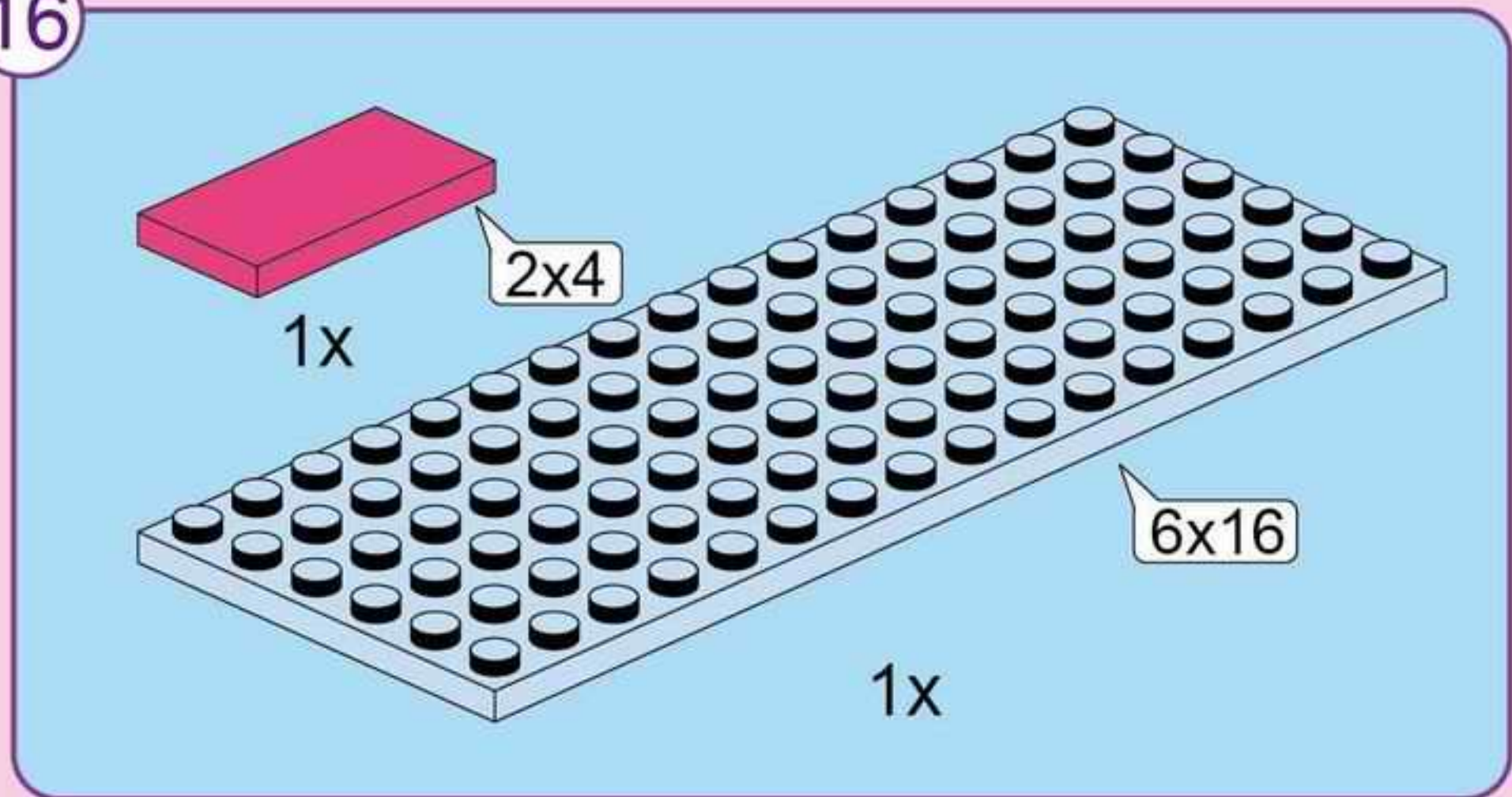



19

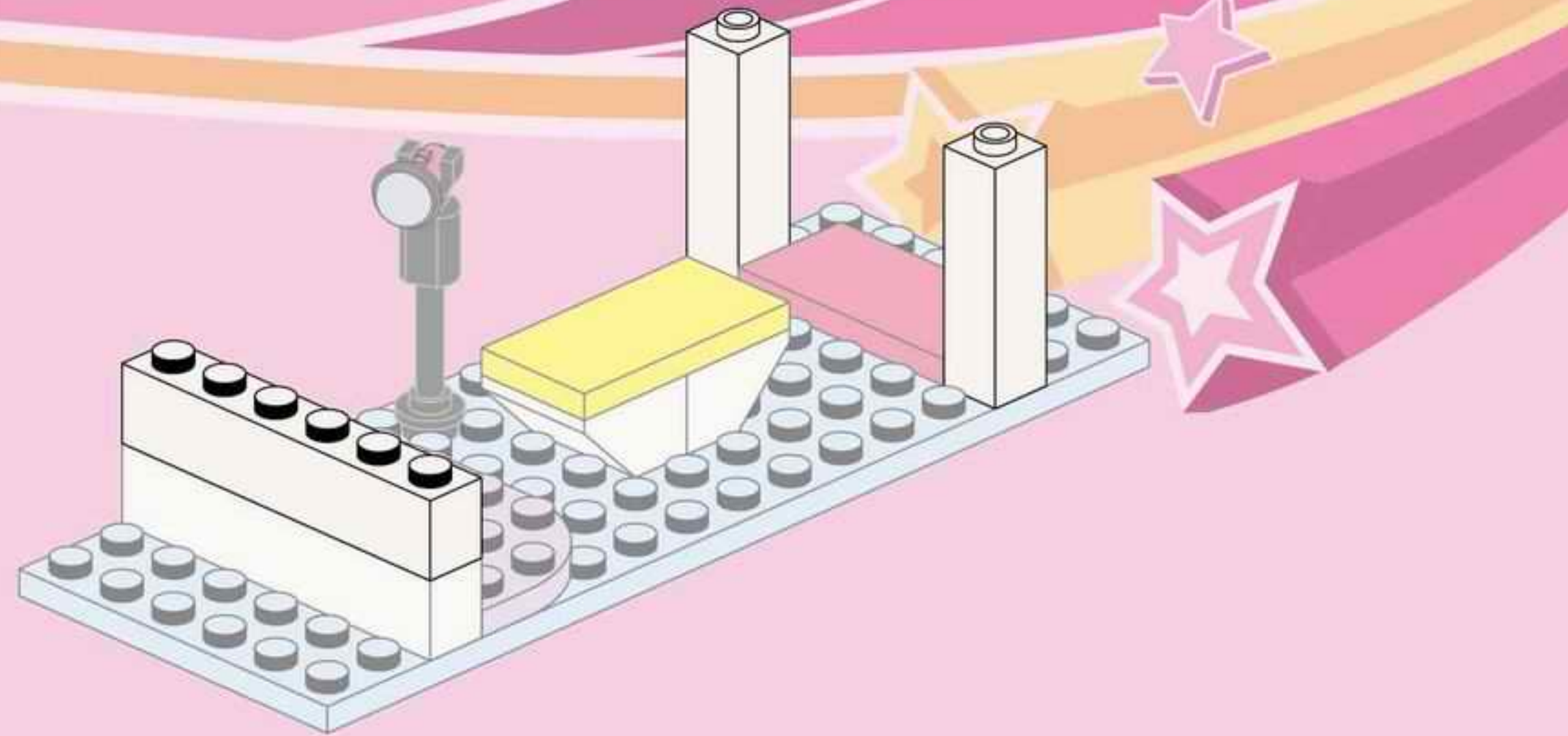
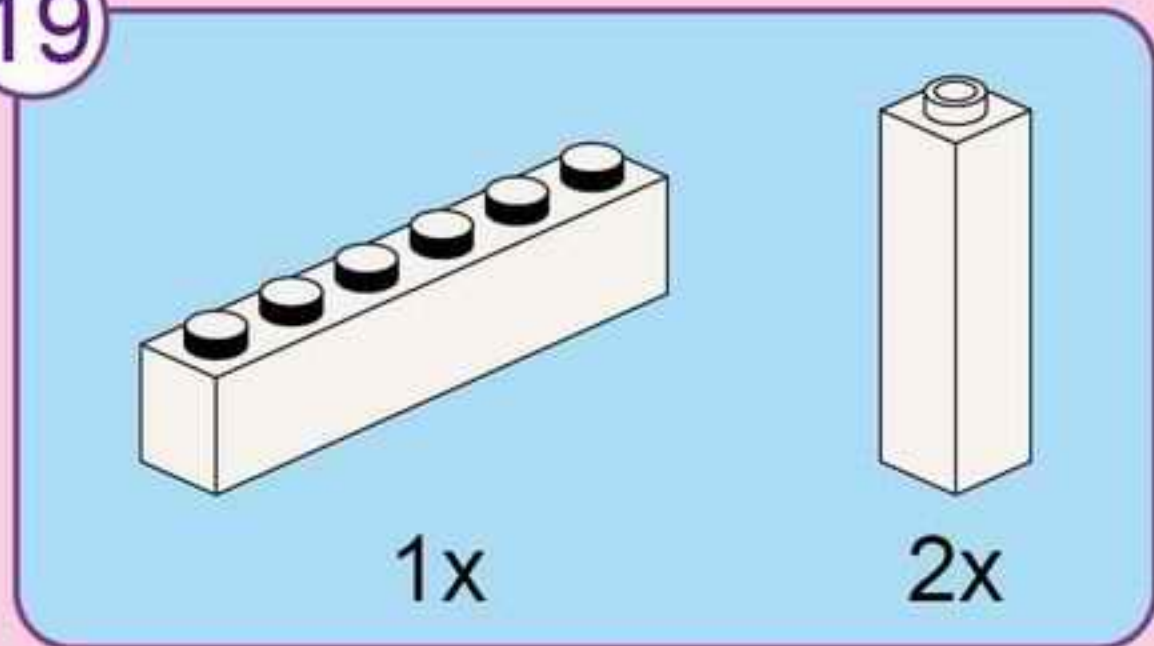

20

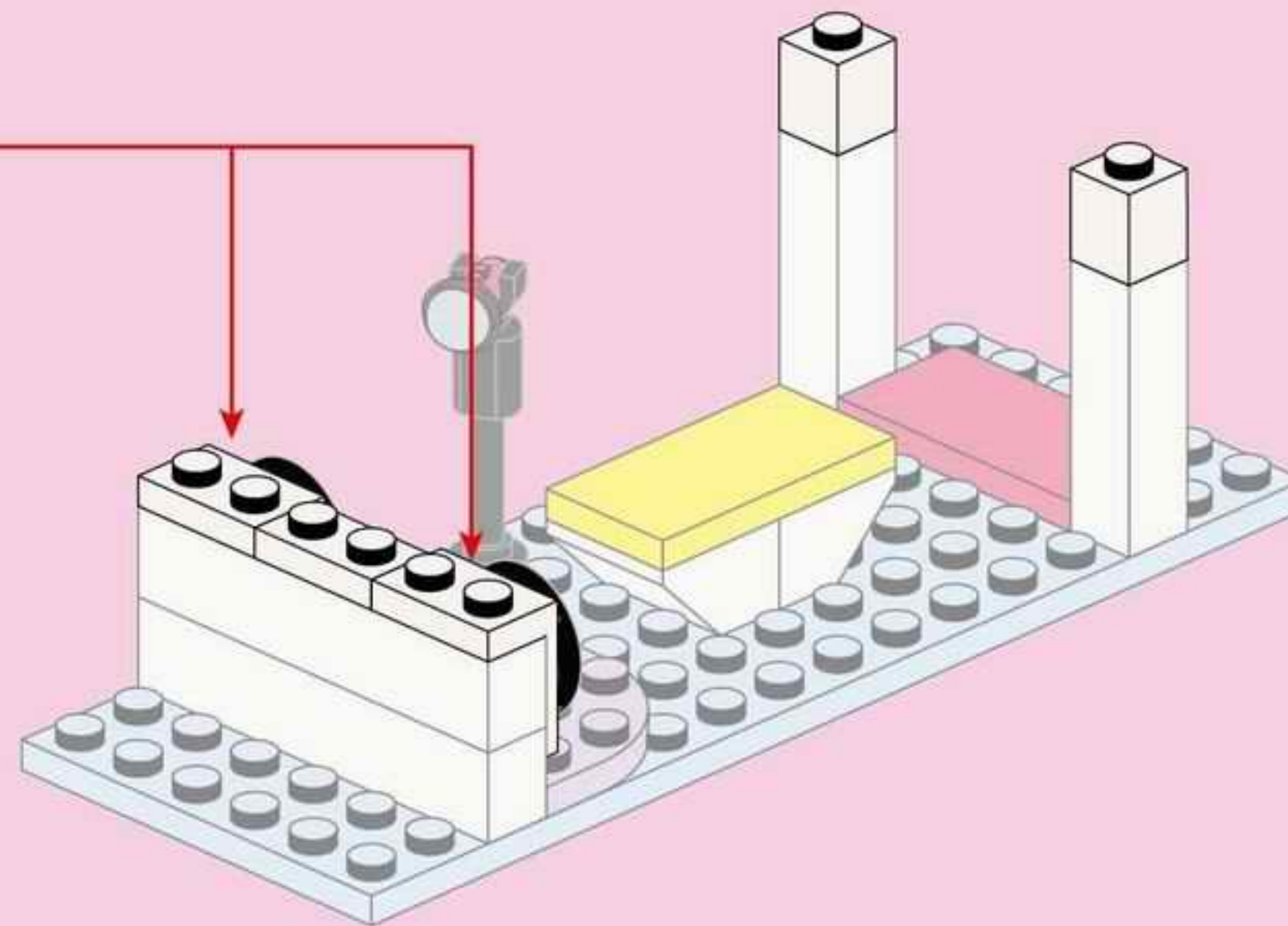
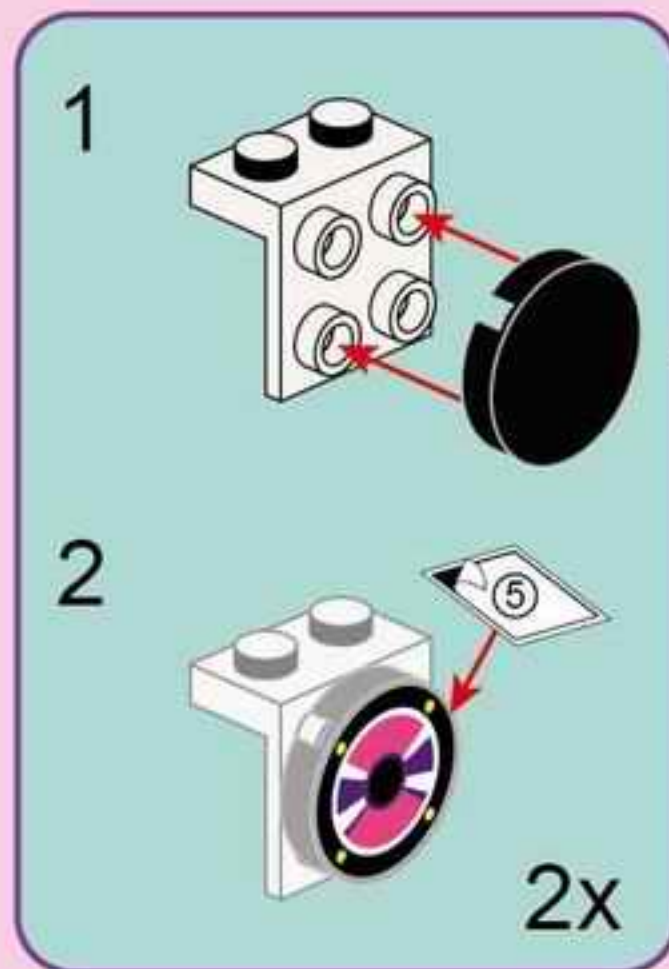
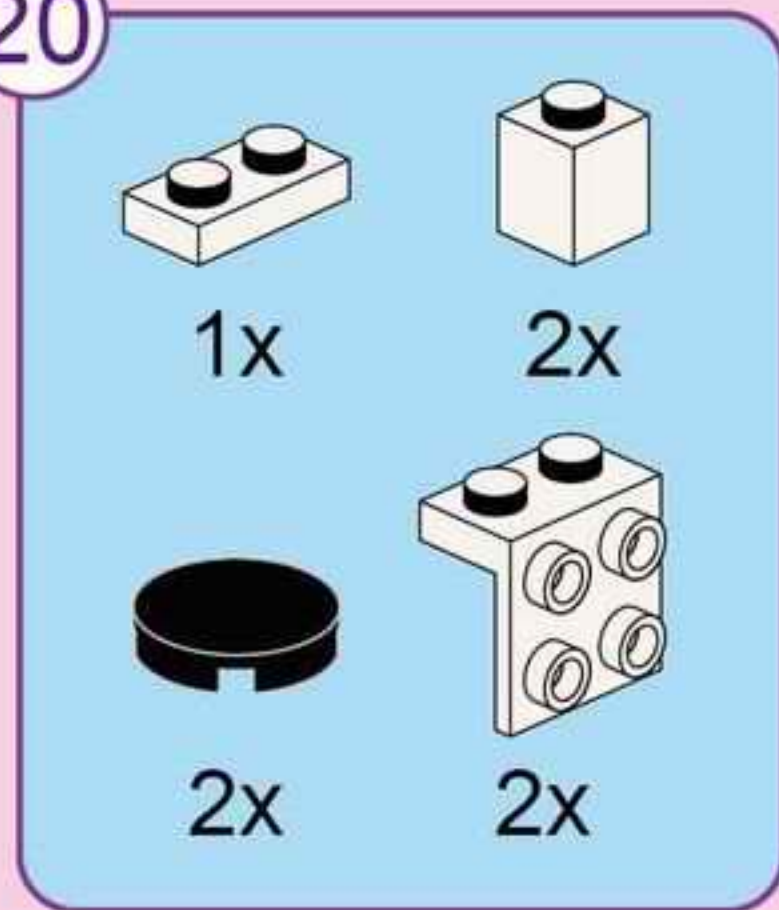



21

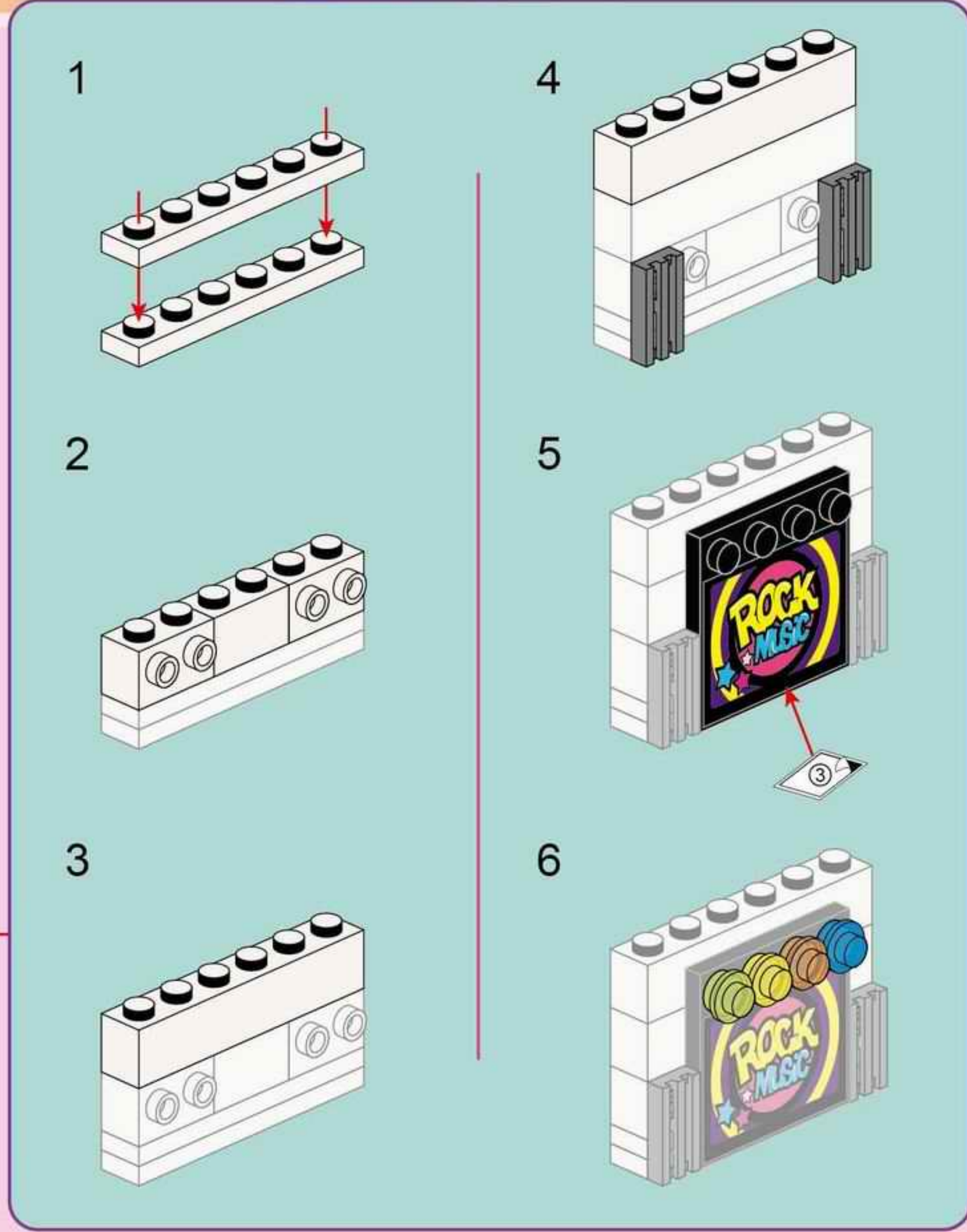
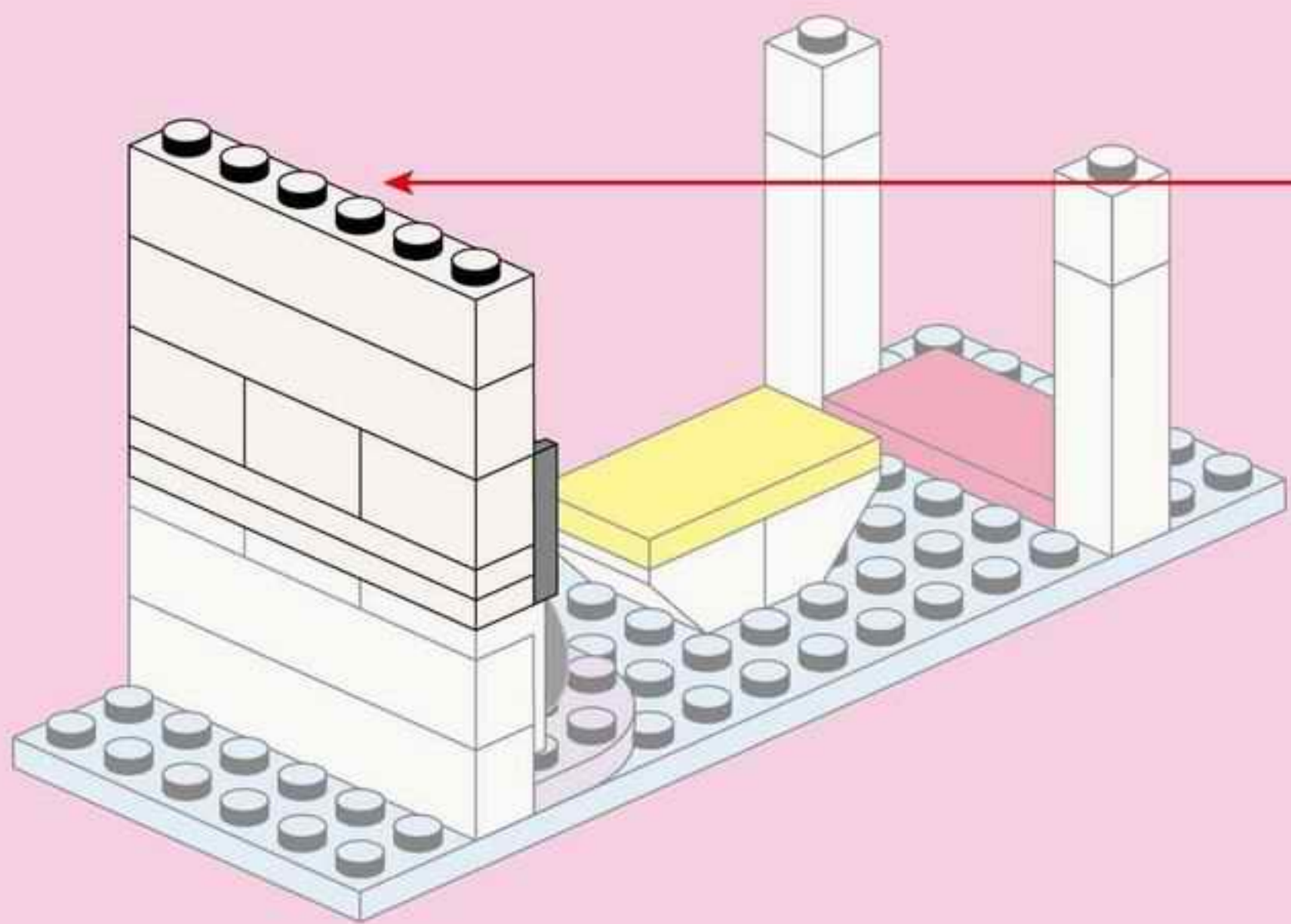
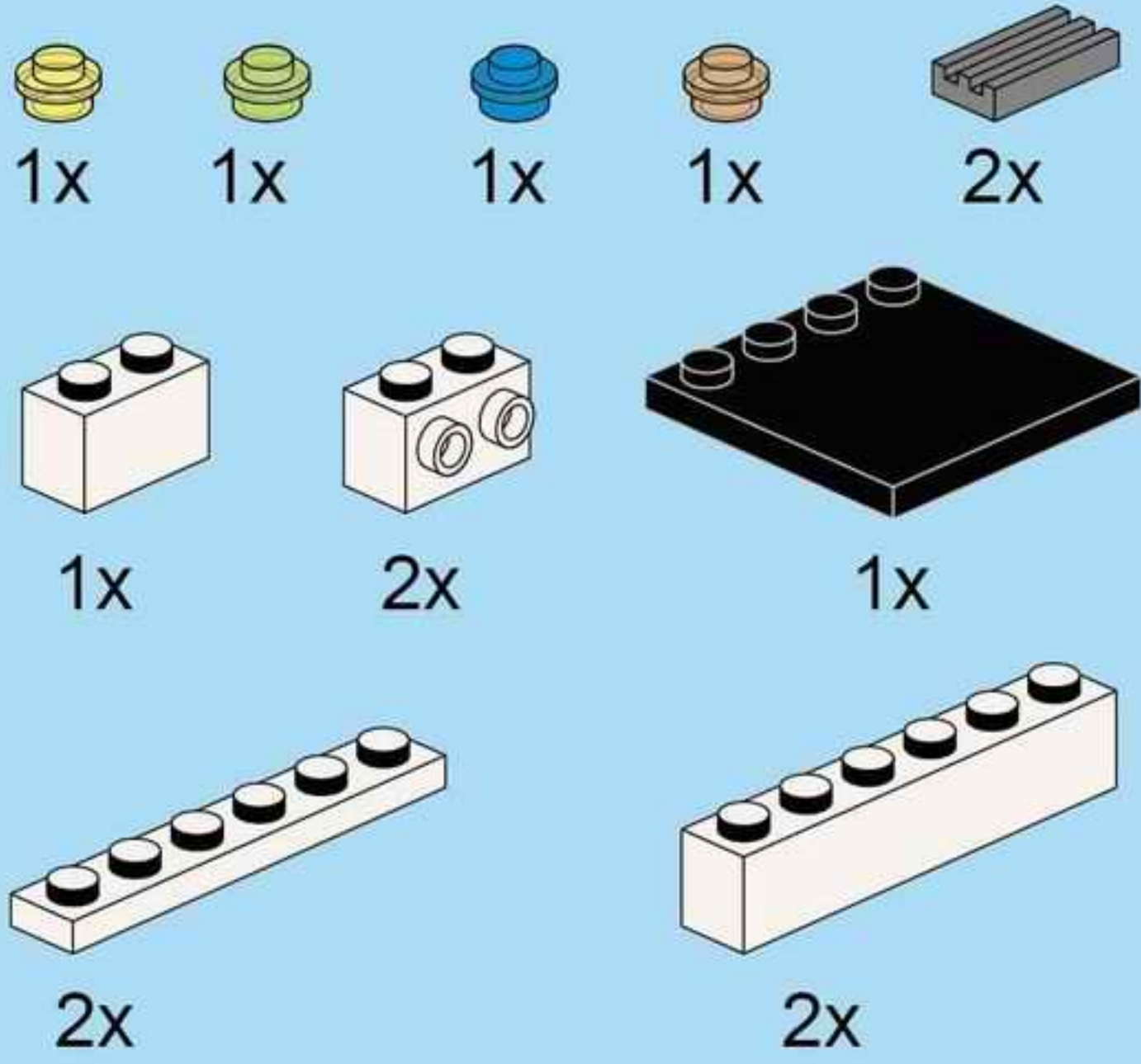

22

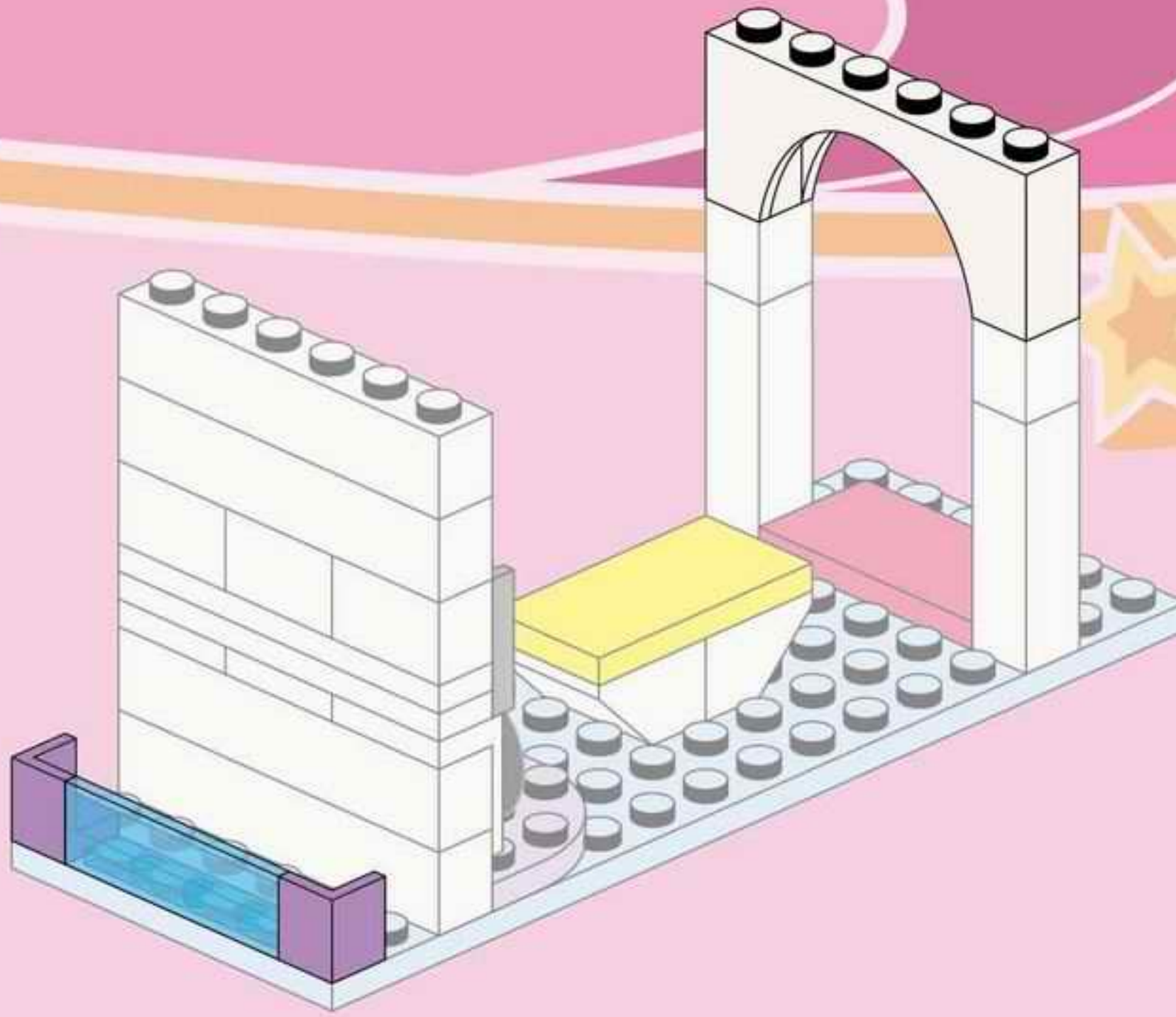
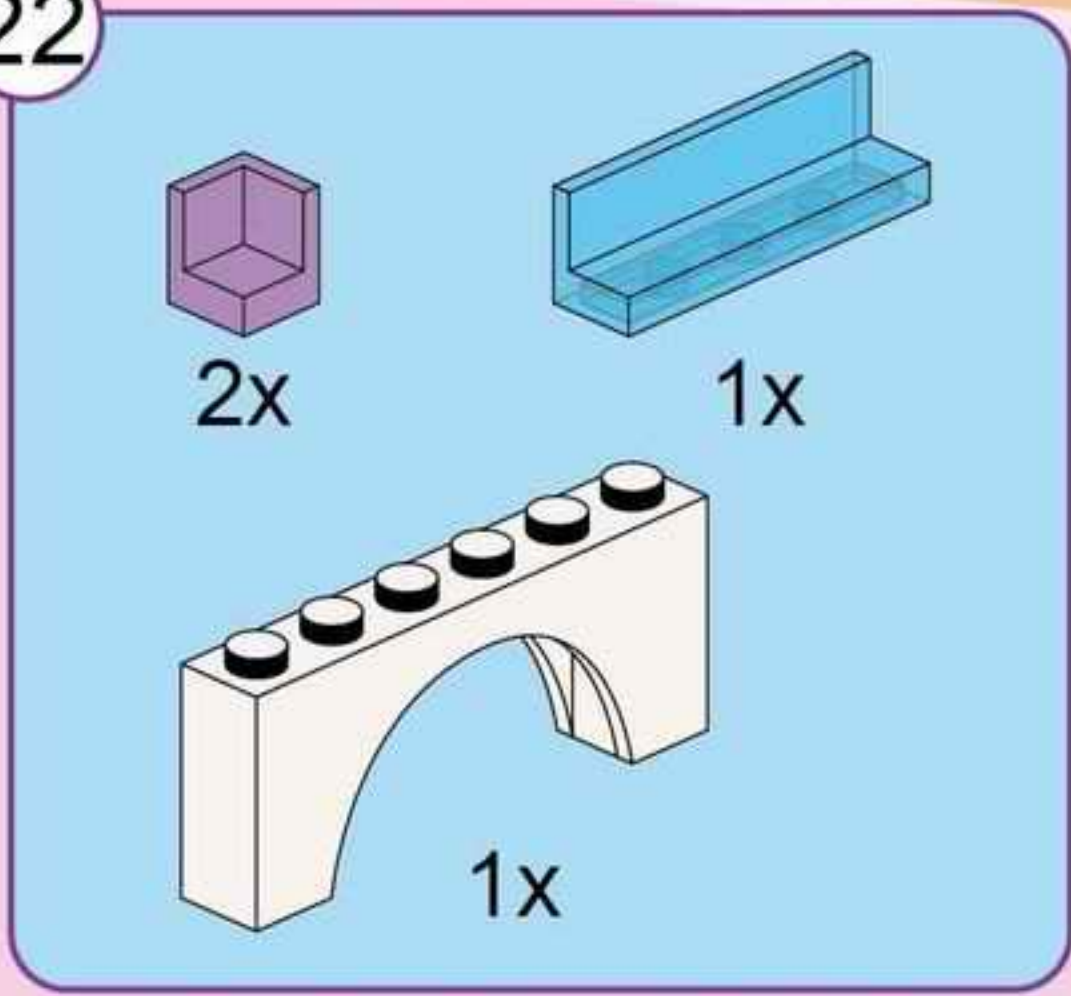

23

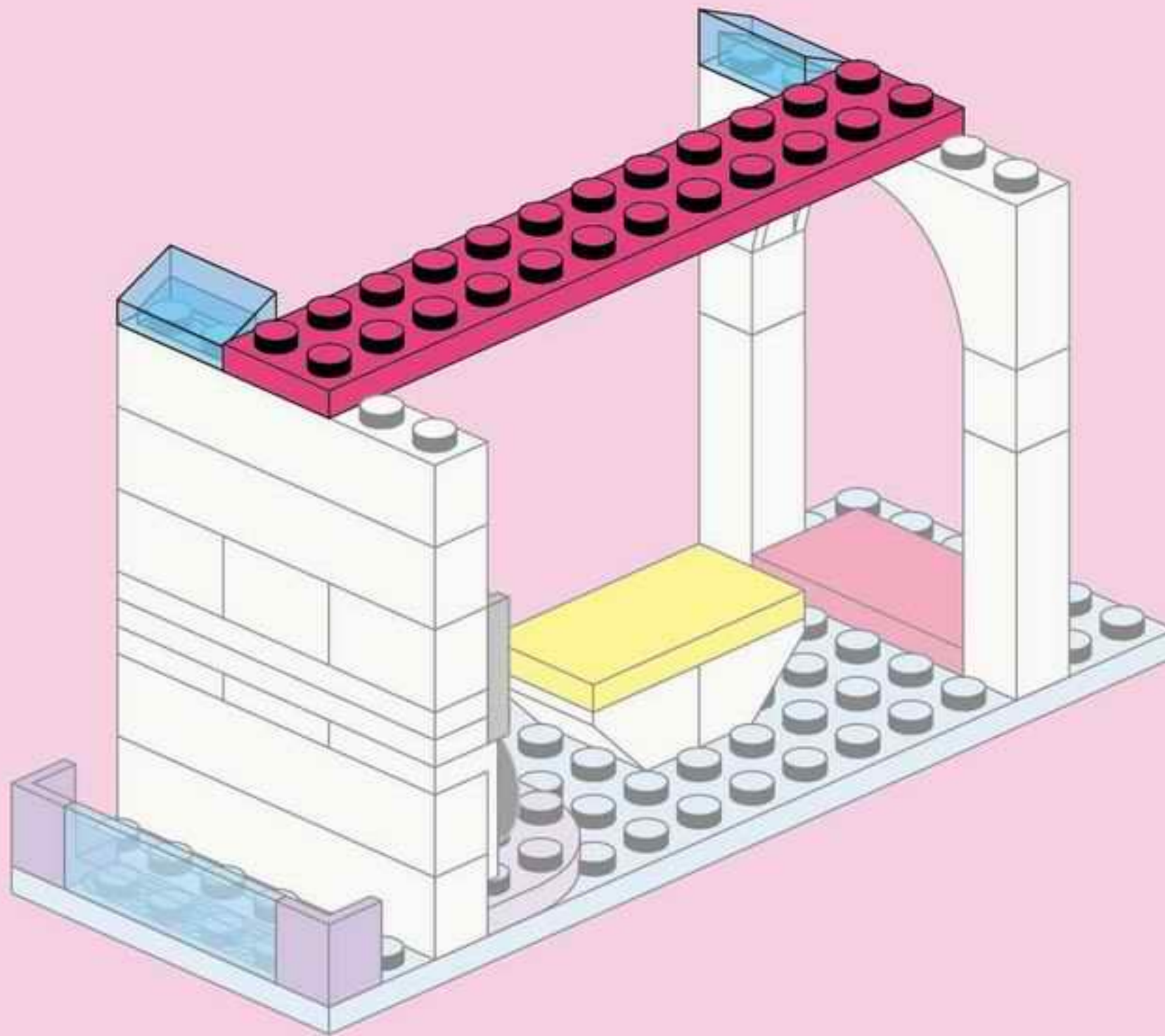
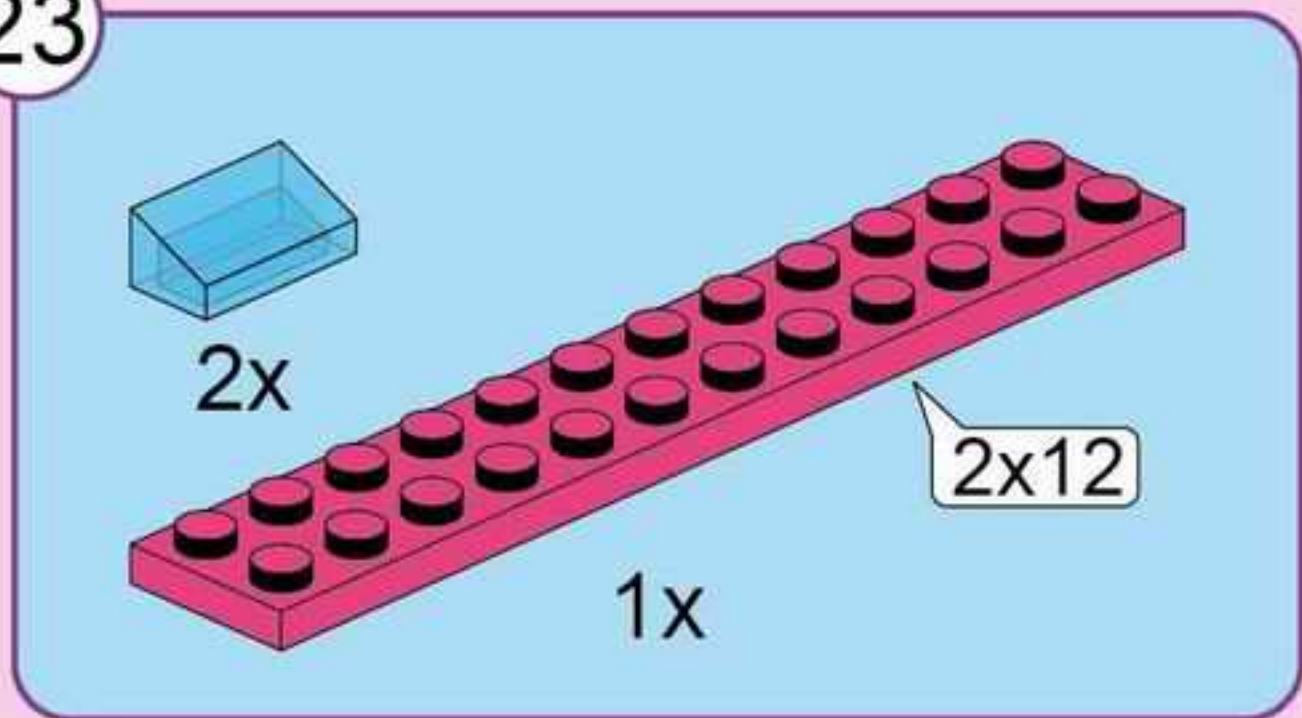

24

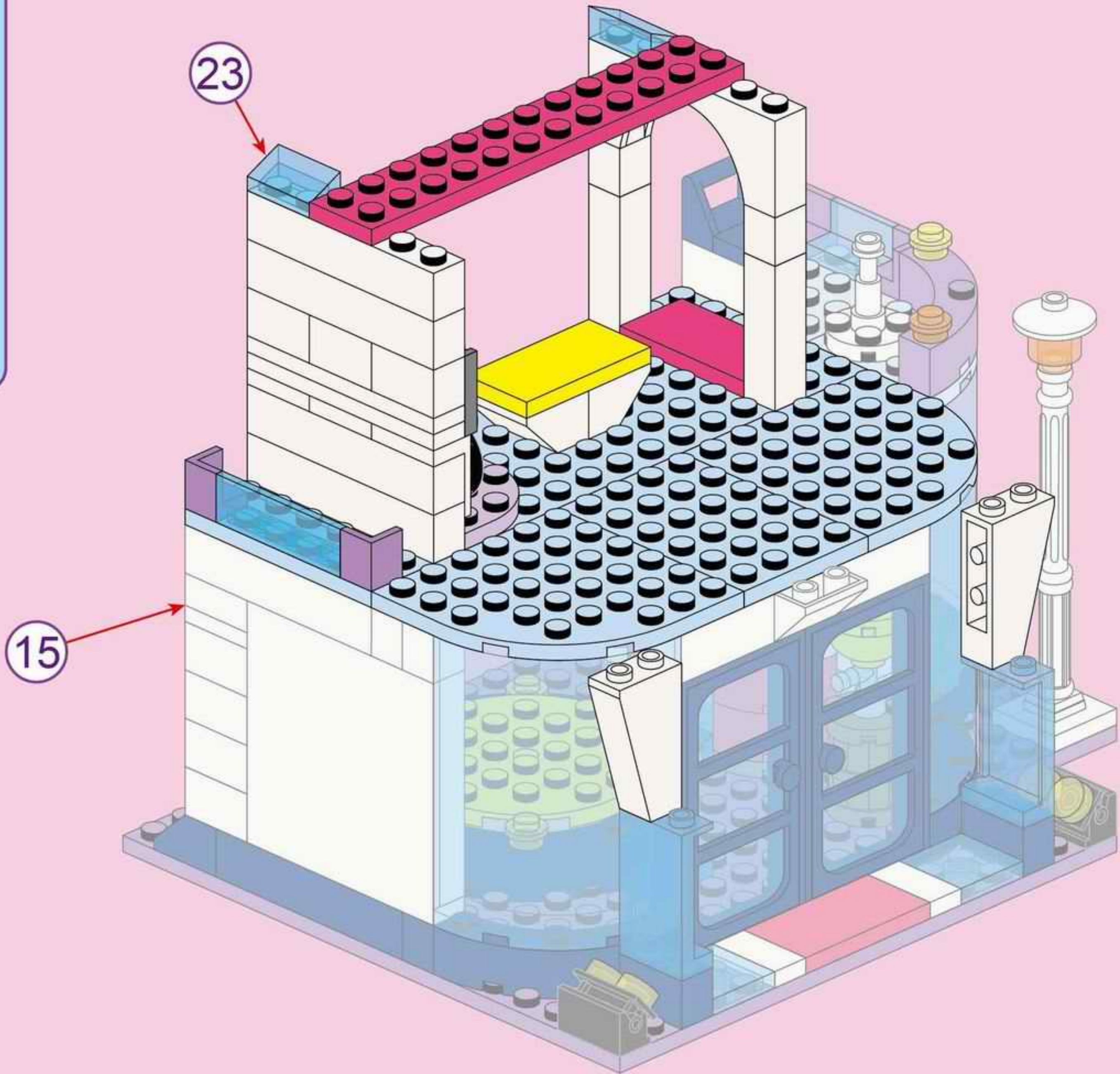
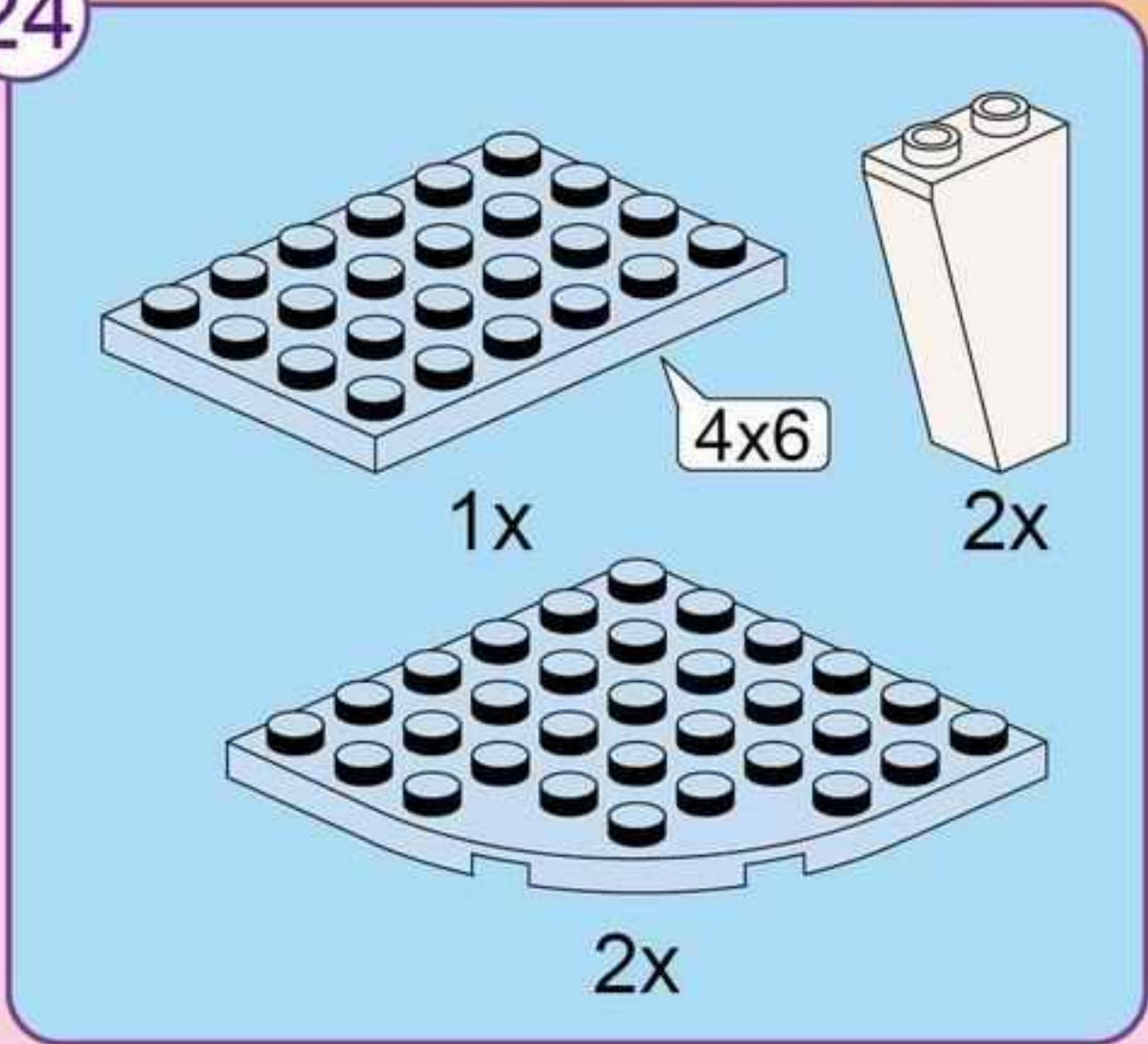

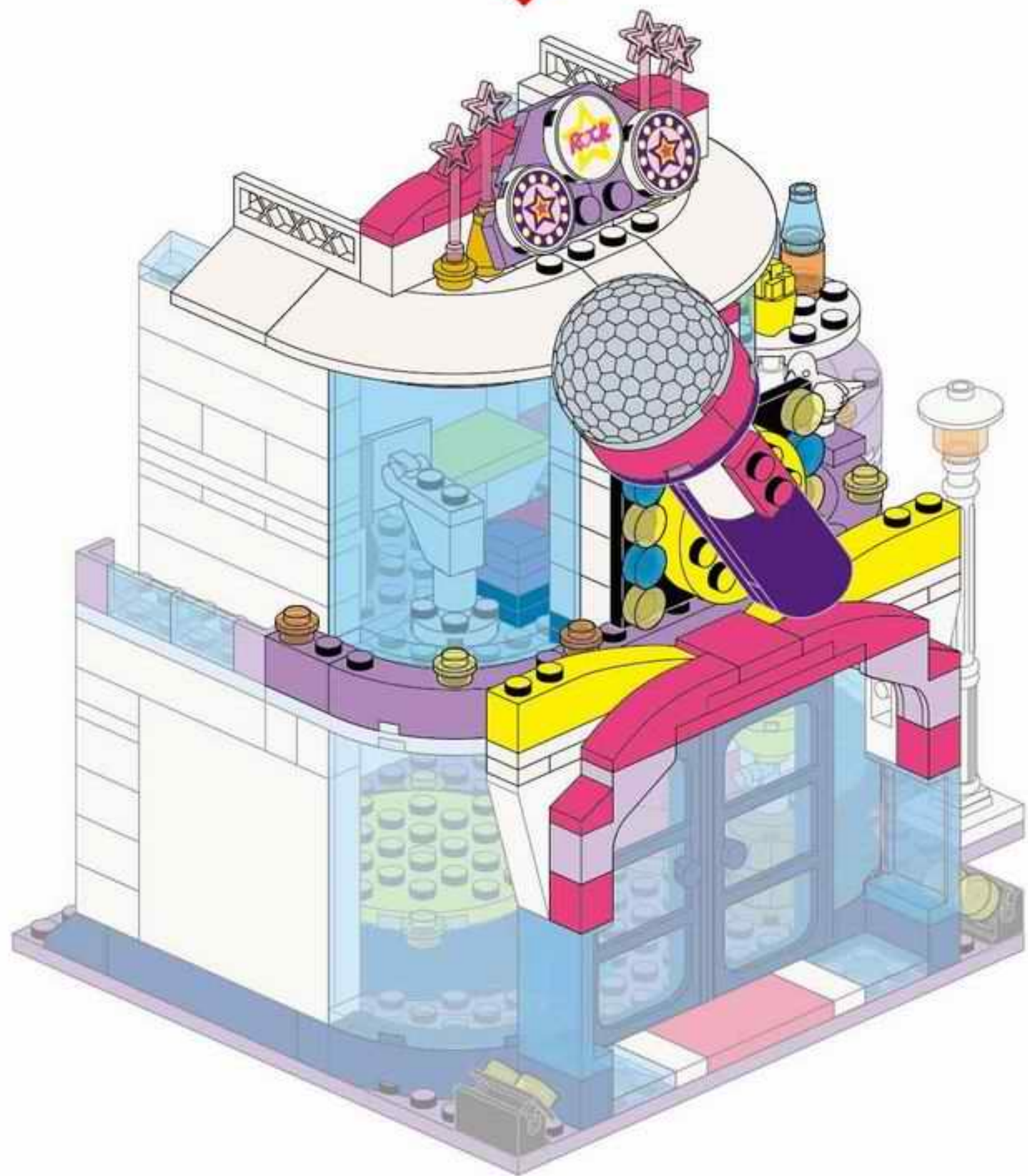



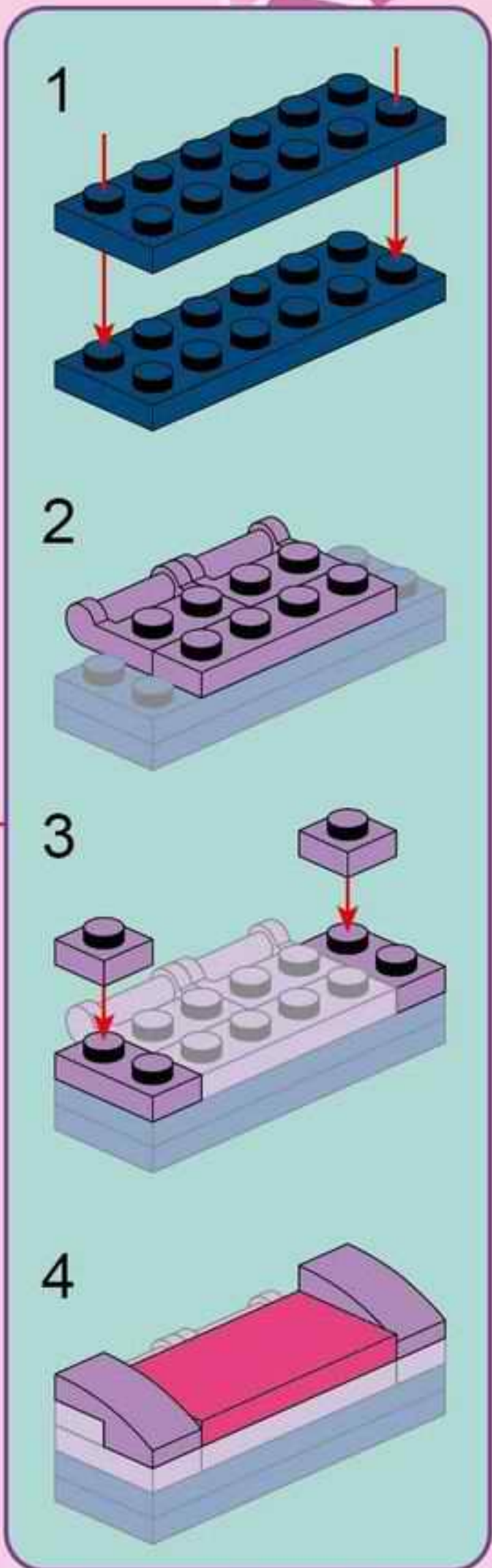
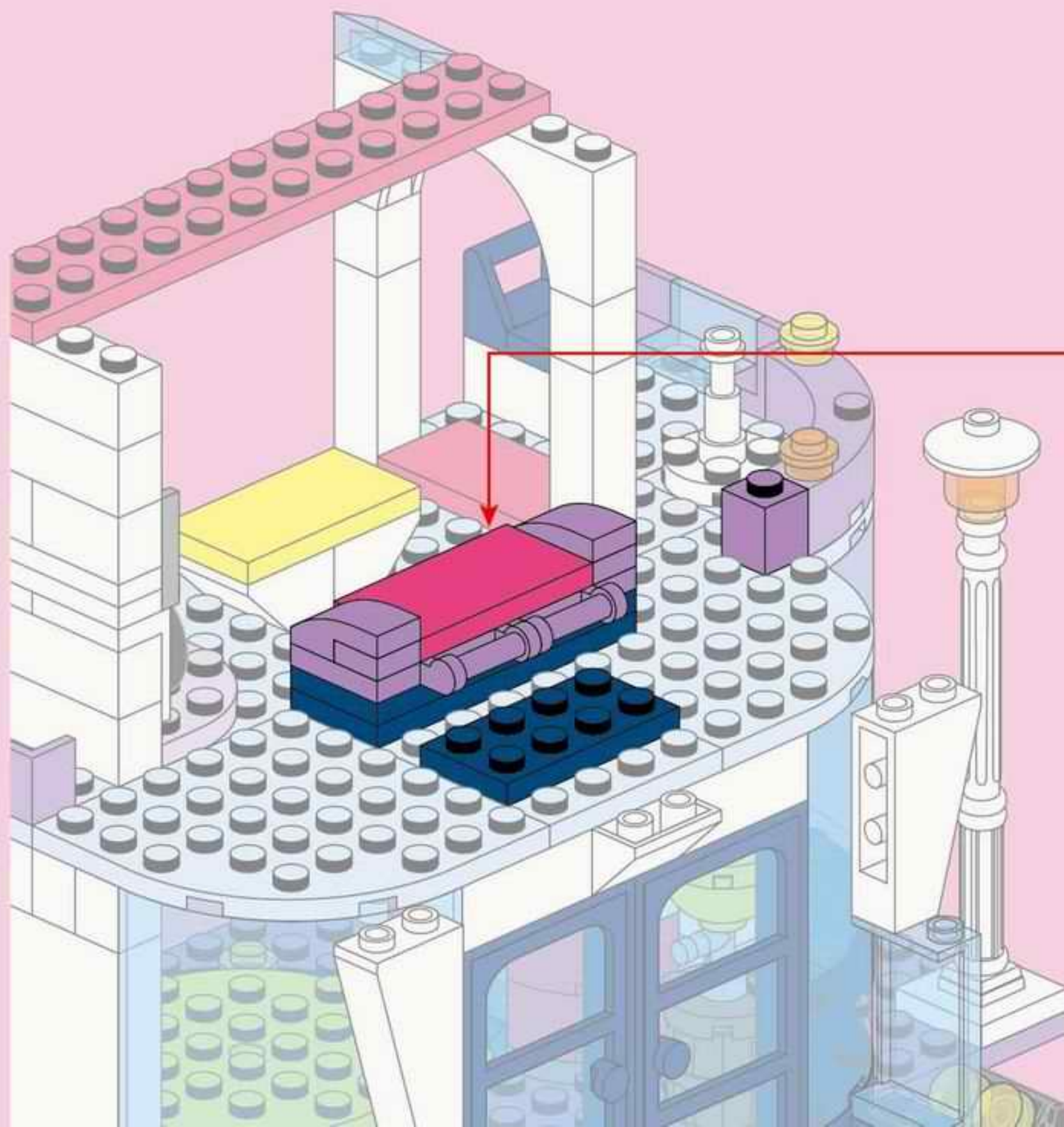
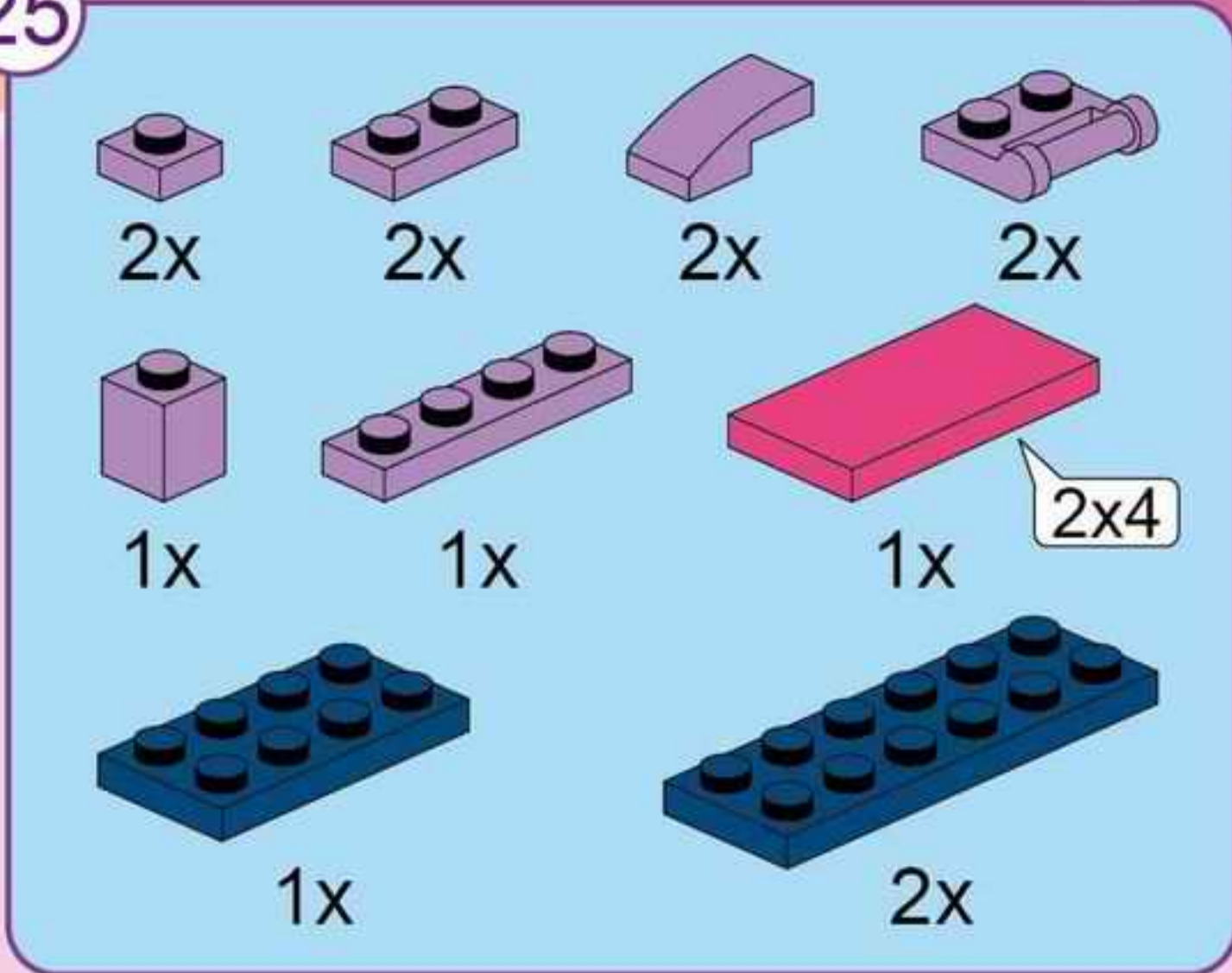







25

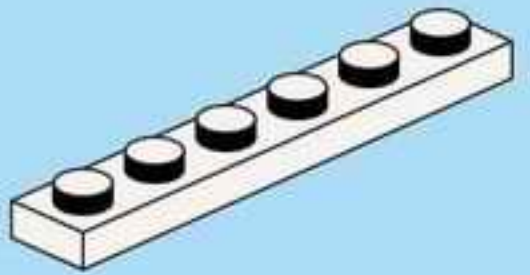

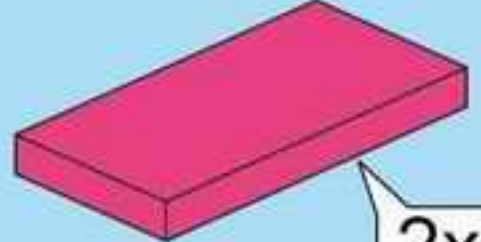
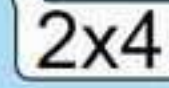
26

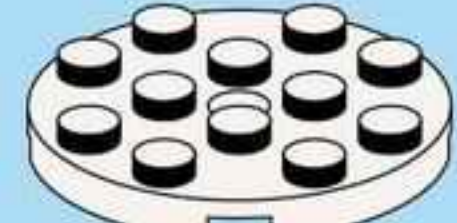
 1x	 1x	 1x
 1x	 1x	
 2x	 2x	
 1x	 1x	
 1x	 1x	

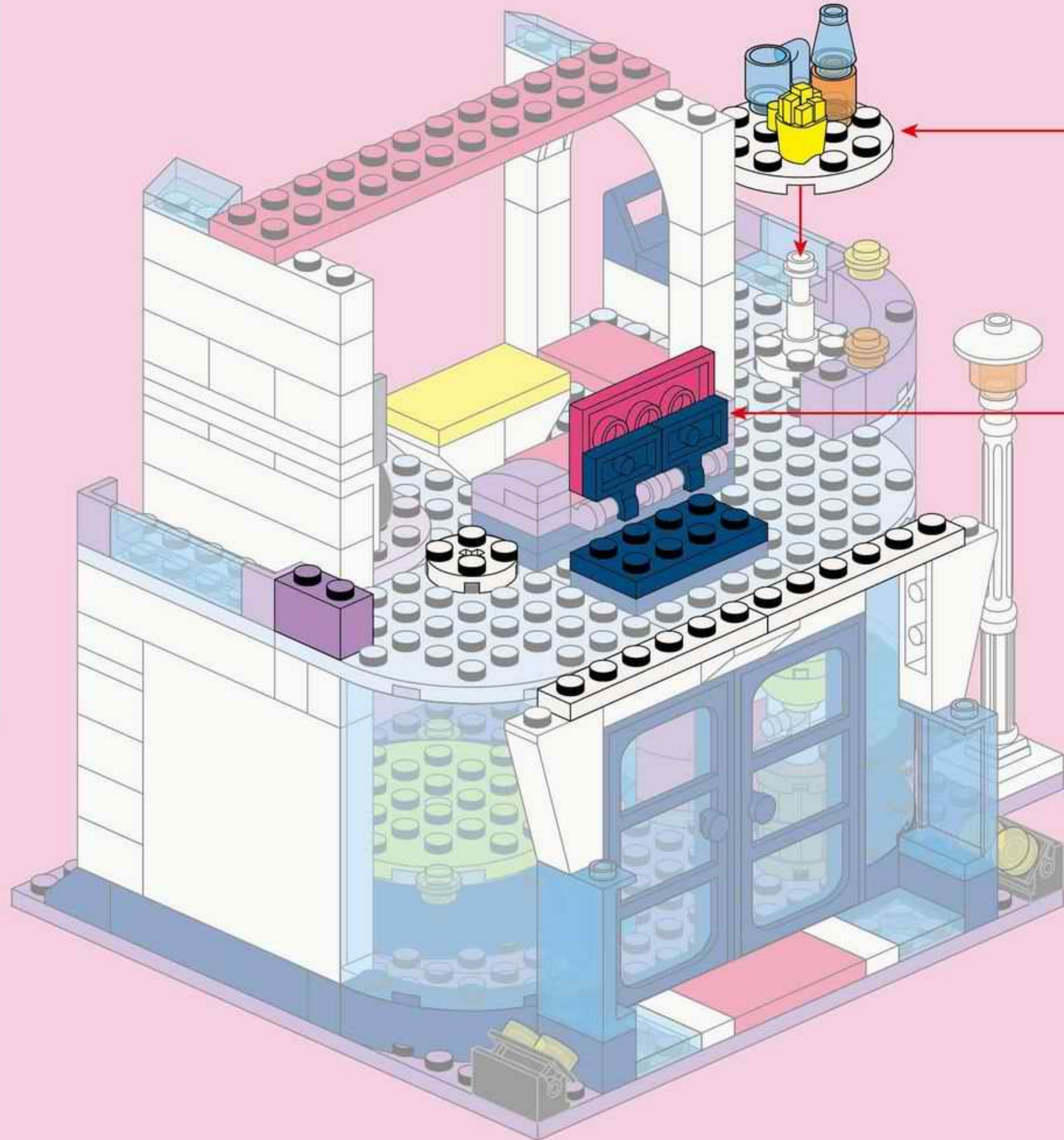



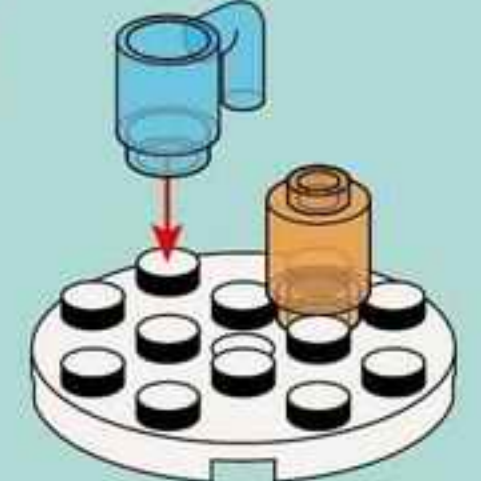

1

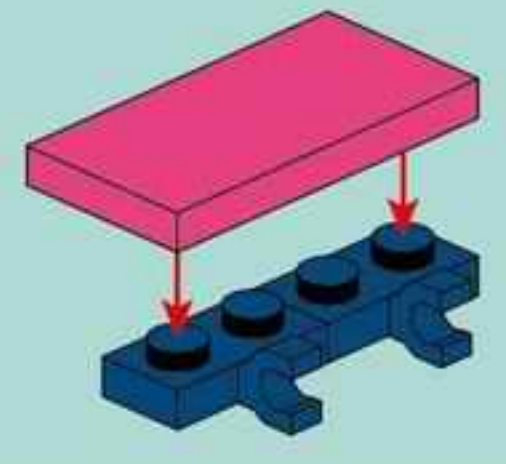
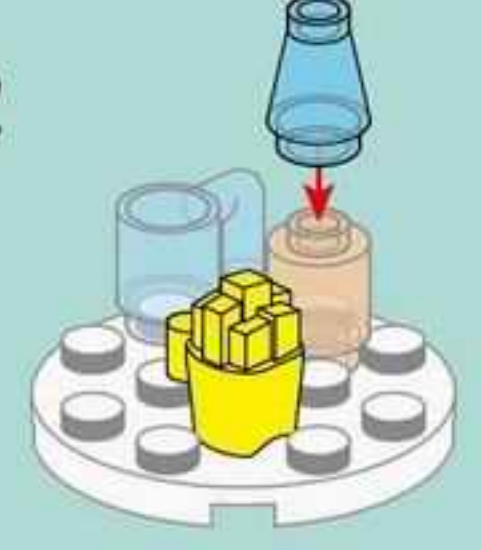

2

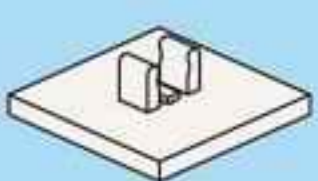

27

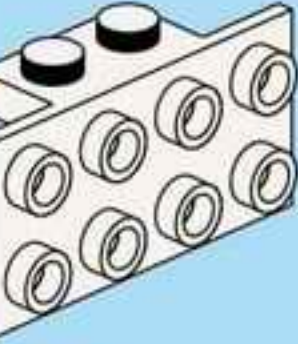
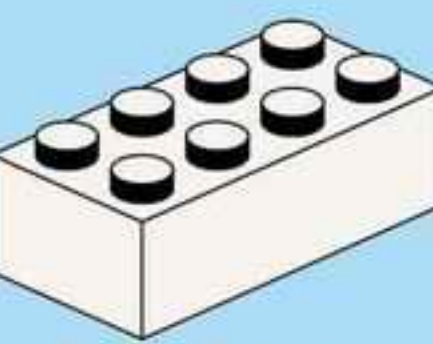
- 1x 
- 1x 
- 1x 
- 2x 
- 1x 
- 1x 
- 3x 

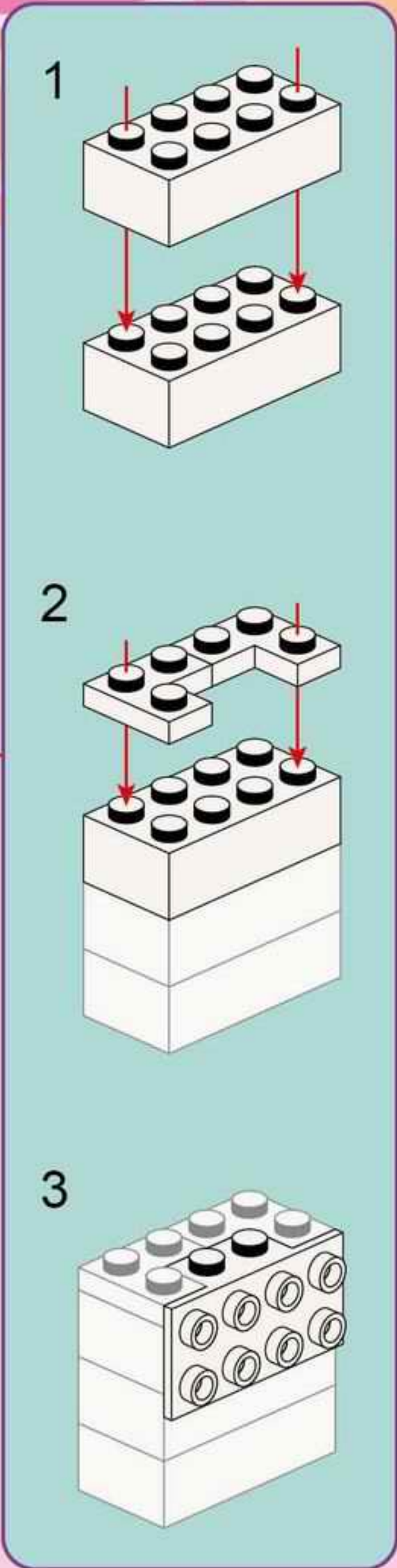
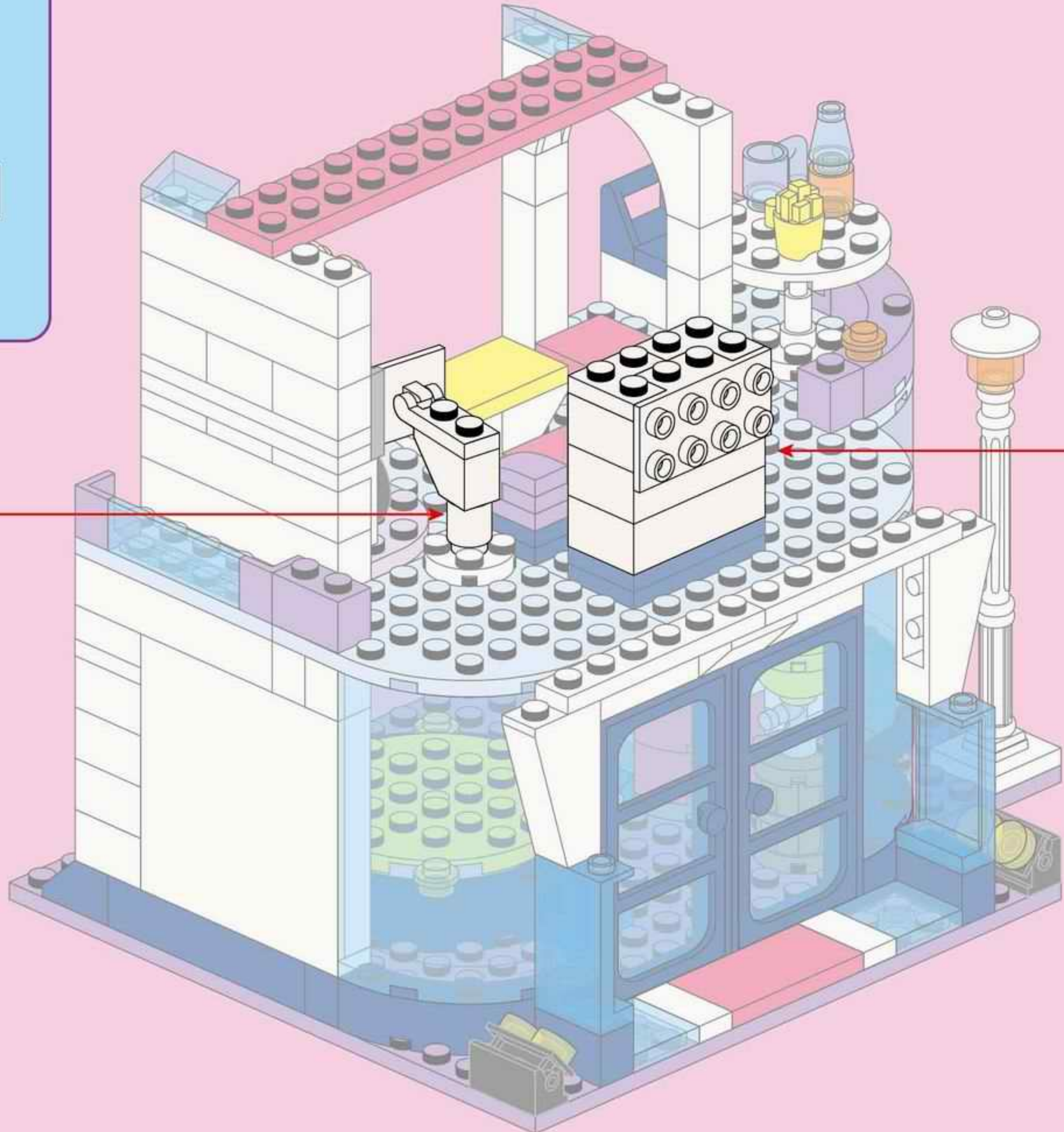
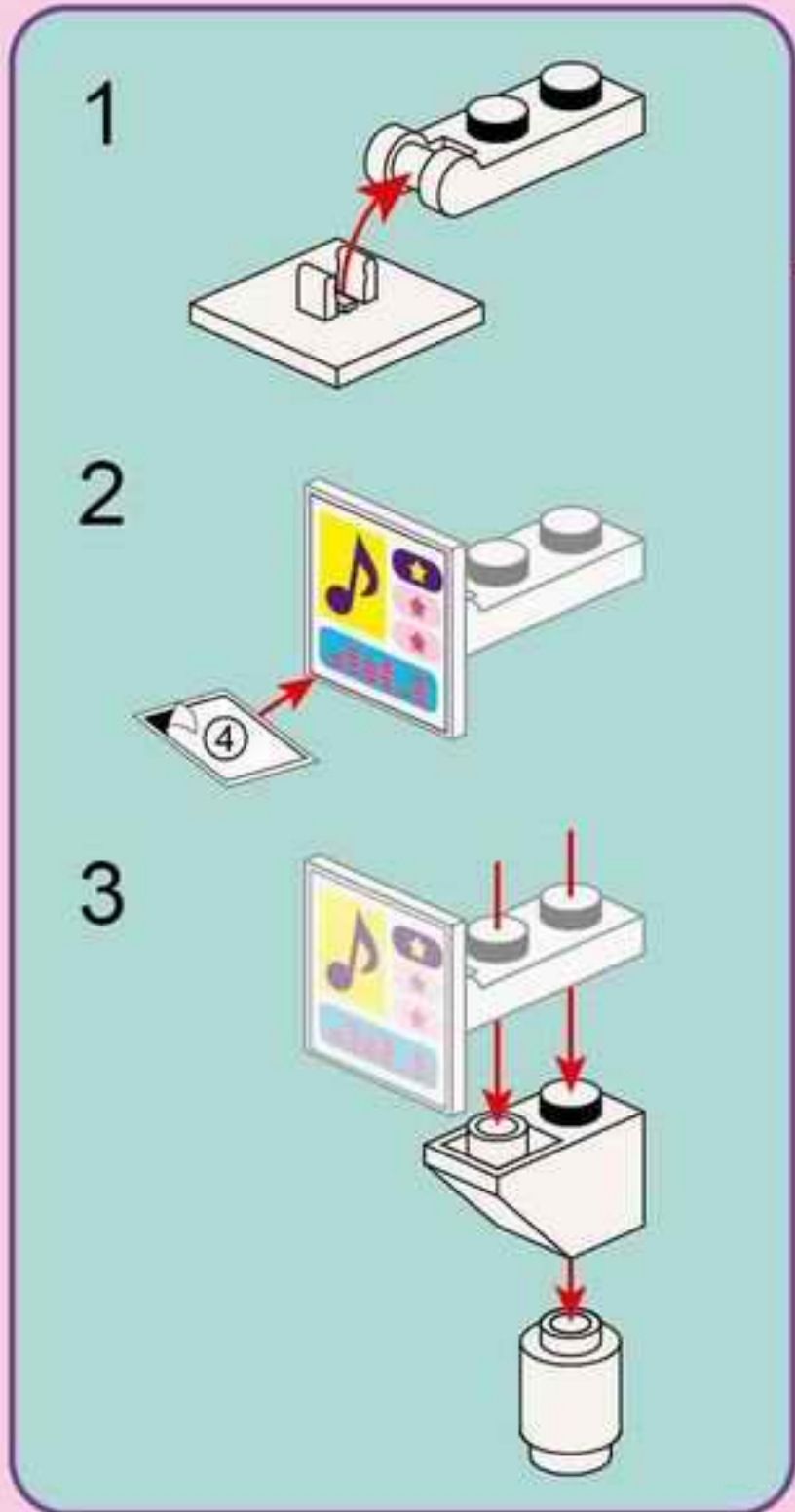

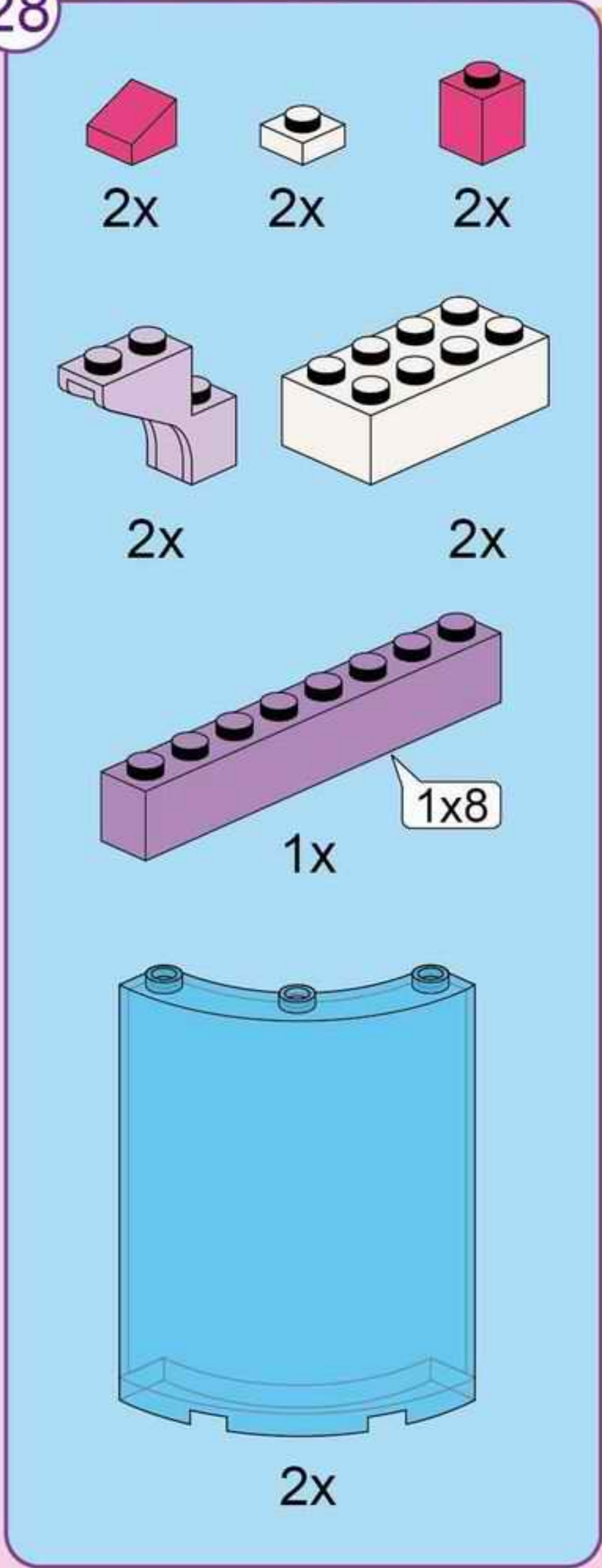

Parts list for step 28:

- 2x Red 1x2 Technic Brick with Hole
- 2x White 1x2 Technic Brick with Hole
- 2x Red 1x2 Technic Brick with Hole and Pin
- 2x White 1x2 Technic Brick with Hole and Pin
- 2x Purple 1x2 Technic Brick with Hole and Pin
- 2x White 1x5 Technic Brick with Hole
- 1x Purple 1x8 Technic Brick with Hole
- 2x Blue Curved Technic Panel

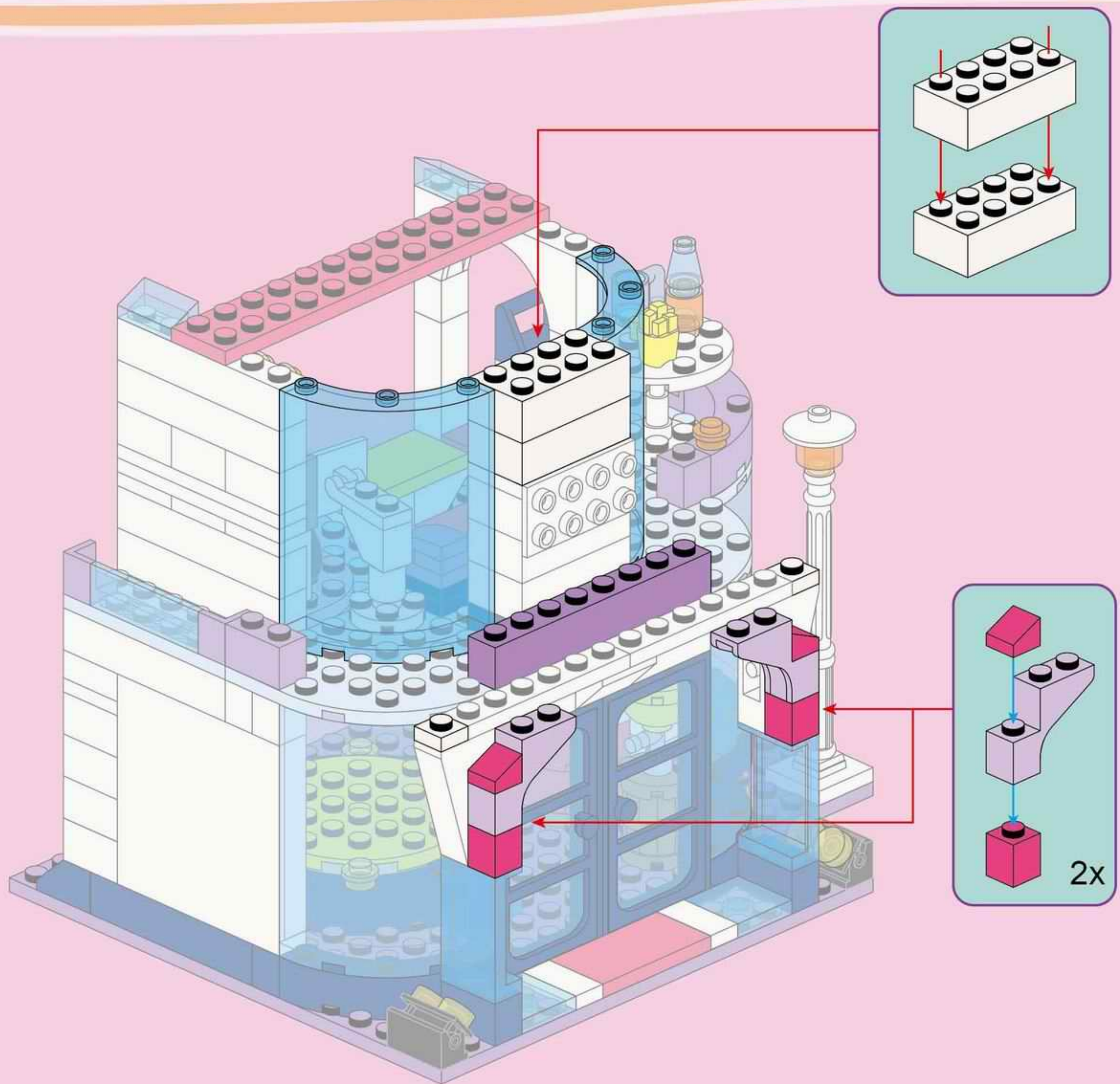





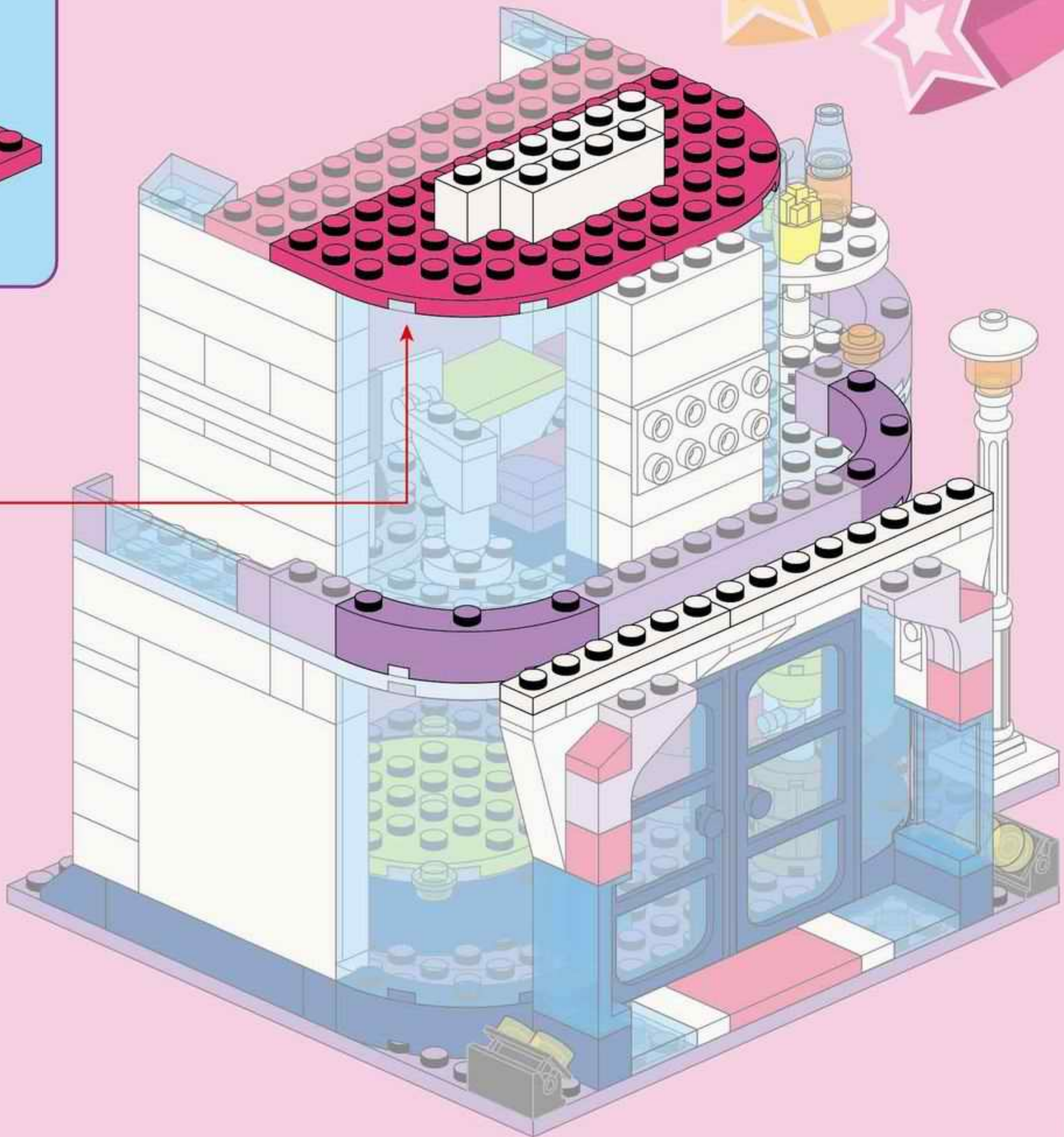
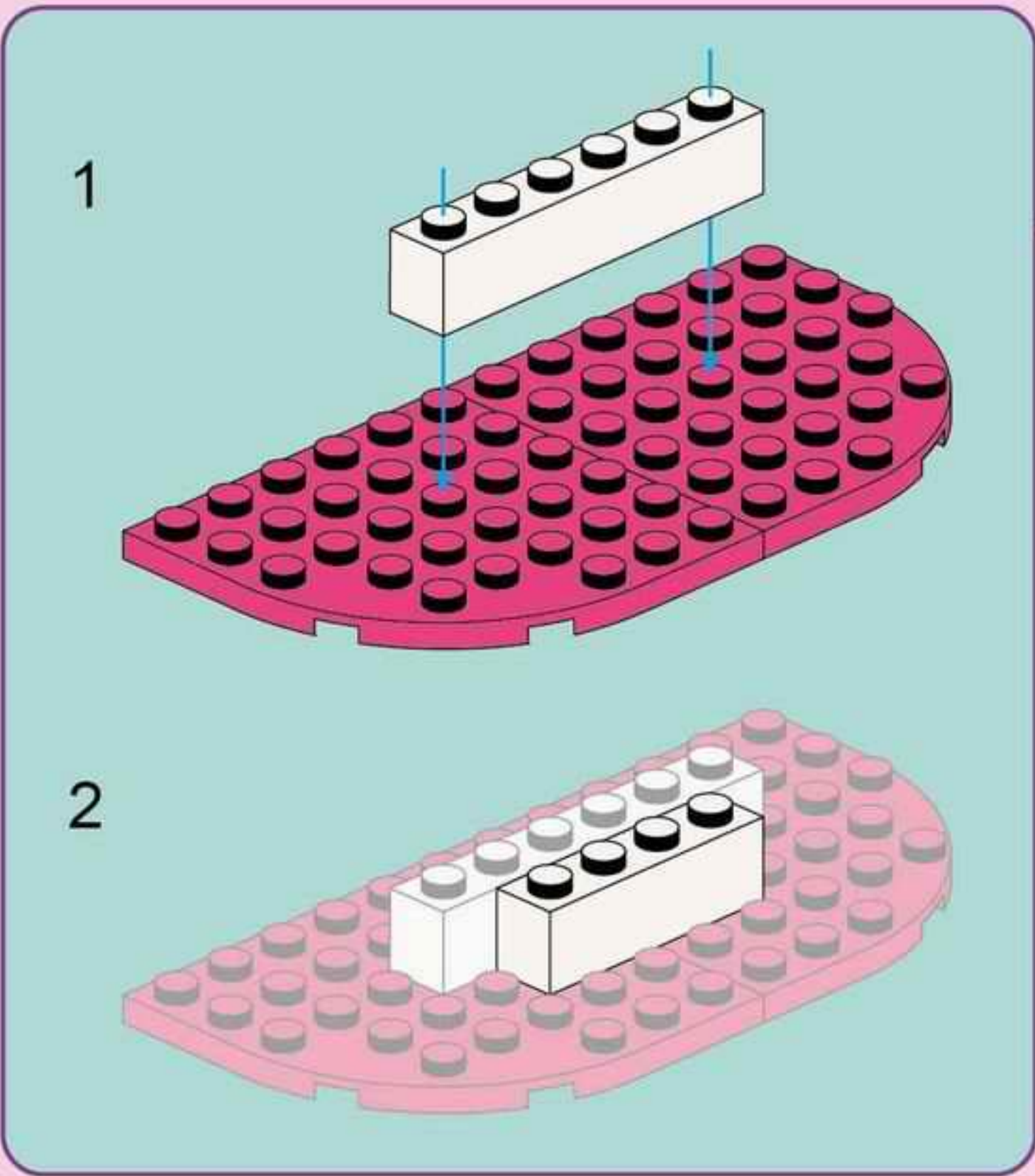
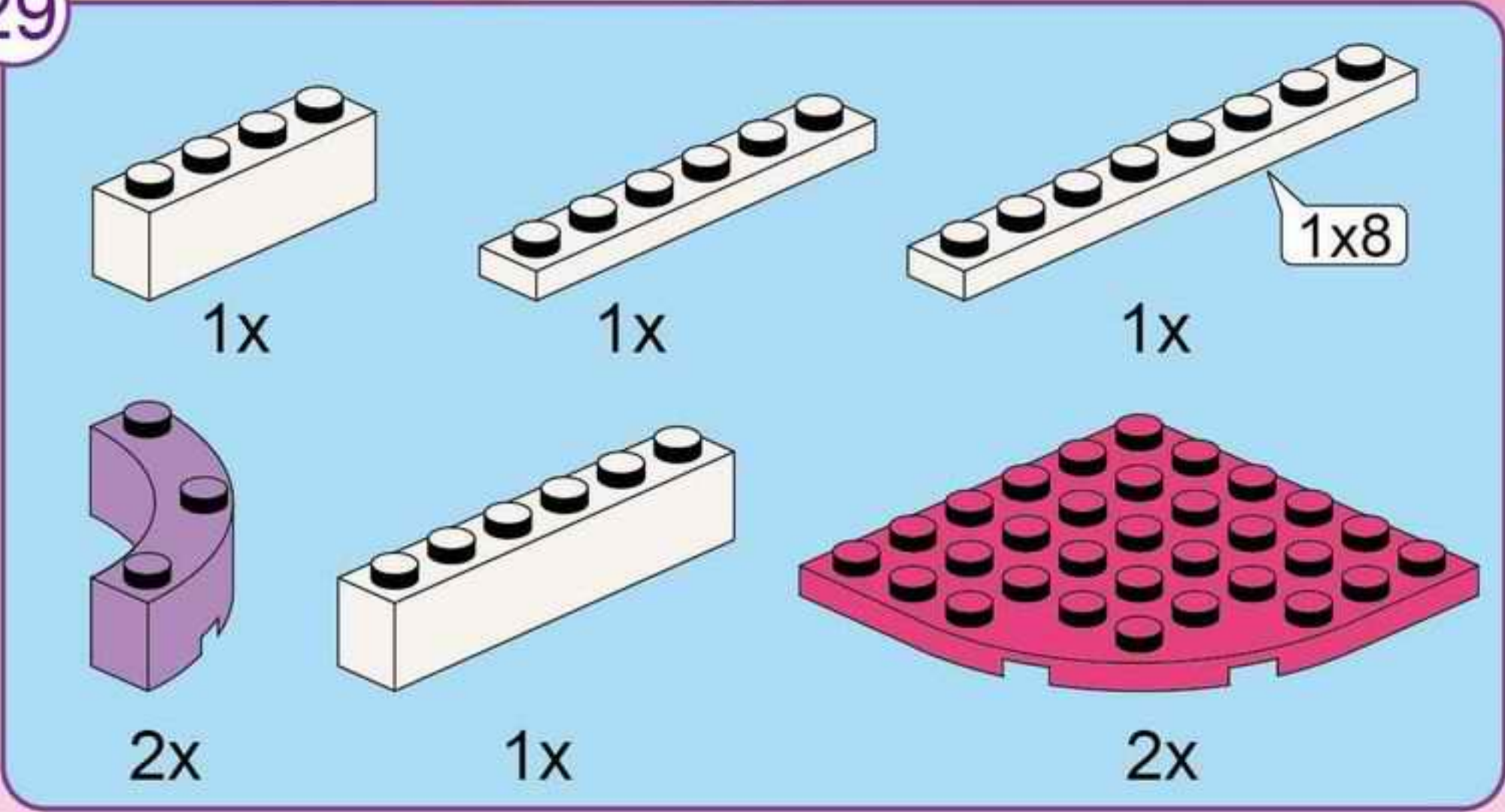

Main assembly diagram for step 28 showing the construction of a building's upper section. The diagram includes two callout boxes:

- Top Callout:** Shows two white 1x5 Technic Bricks with Holes being connected. Red arrows indicate the connection points.
- Bottom Callout:** Shows a vertical stack of three pieces: a red 1x2 Technic Brick with Hole and Pin, a white 1x2 Technic Brick with Hole and Pin, and another red 1x2 Technic Brick with Hole and Pin. A blue arrow indicates the assembly direction, and the quantity '2x' is noted.

29

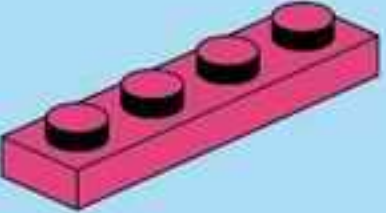
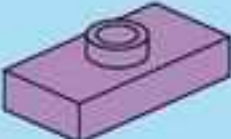

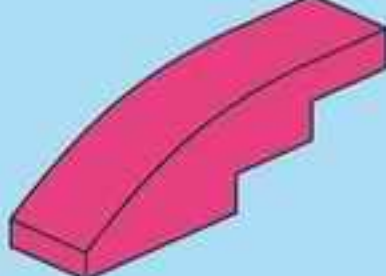

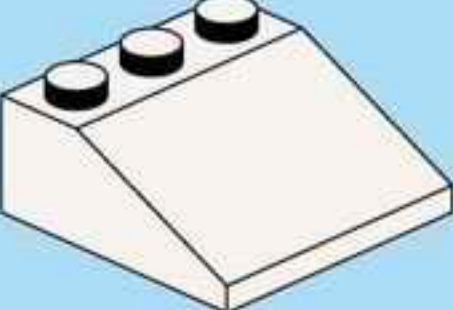
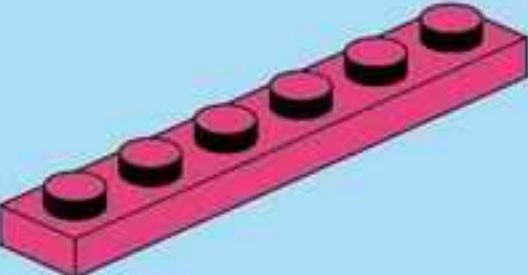
		
2x	3x	2x
		
1x	1x	2x
		
1x	2x	1x

1

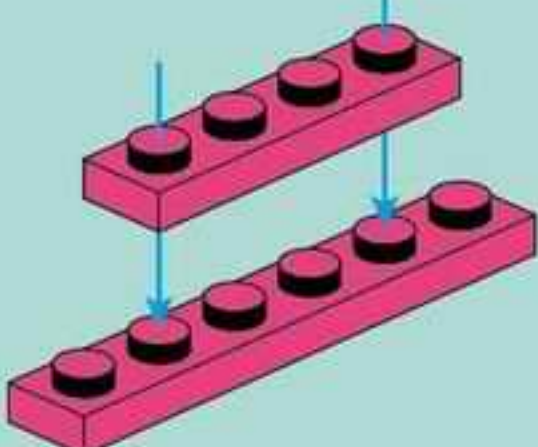

2

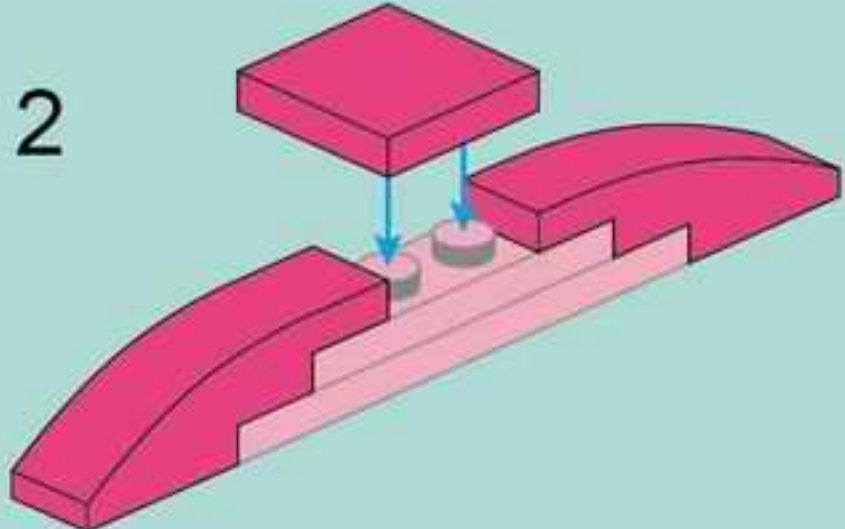

The main assembly diagram shows a multi-story building with a red roof. A white bird is perched on a purple base on the right side. A red line connects this bird to an inset diagram in the top right corner. The inset shows a white bird on a purple base with a red arrow pointing to a hole in the base. The building has a blue base and a white upper section. A lamp post is visible on the right side. The building is surrounded by a blue base and a red roof. A red line also connects the inset to the red beams in the main assembly diagram.

31

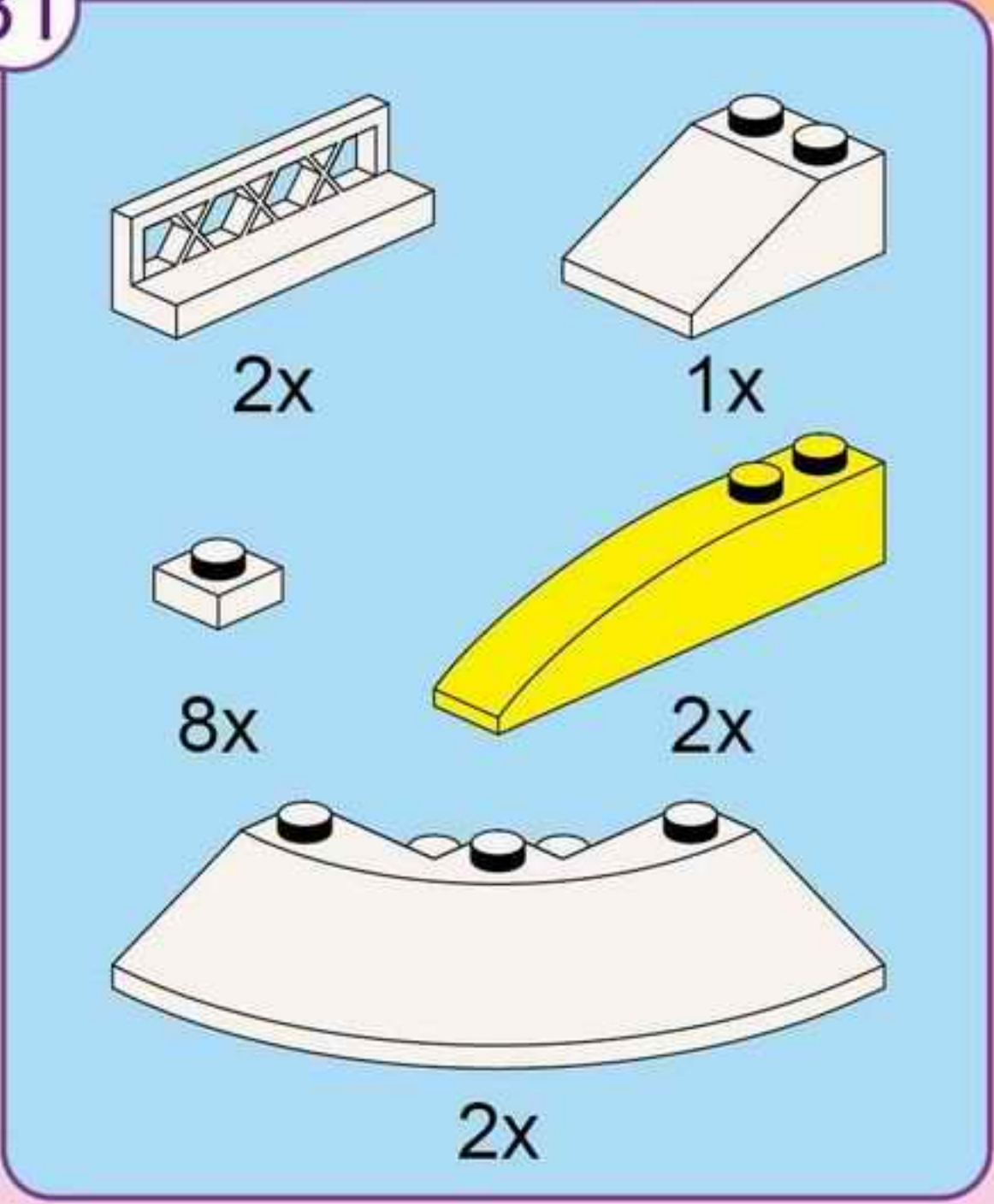

2x  
1x  
8x  
2x  
2x

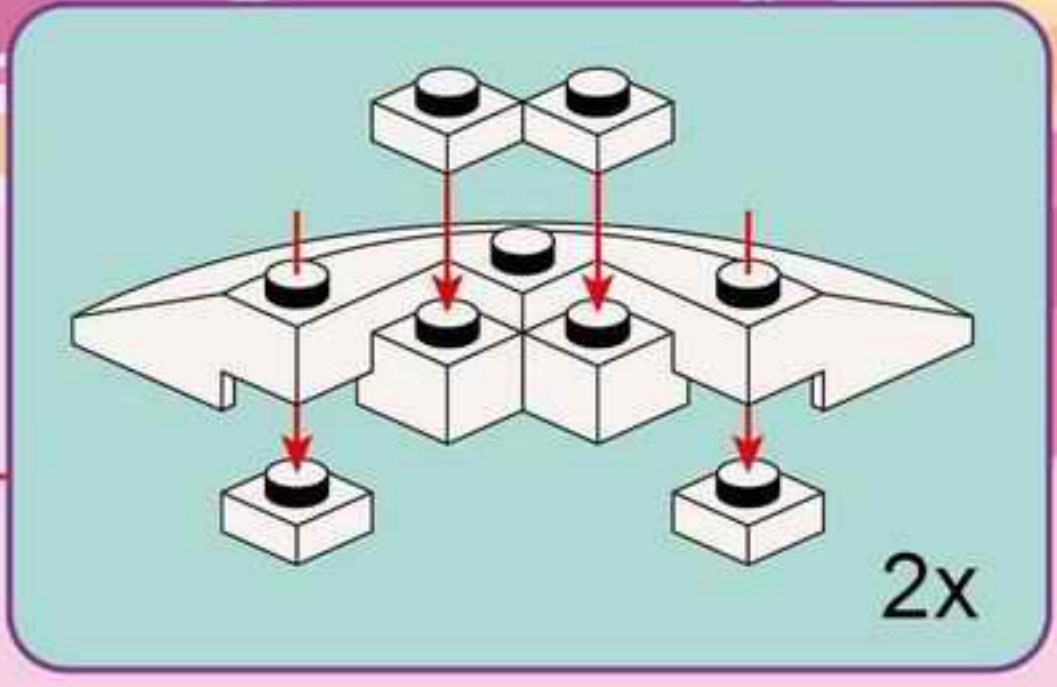
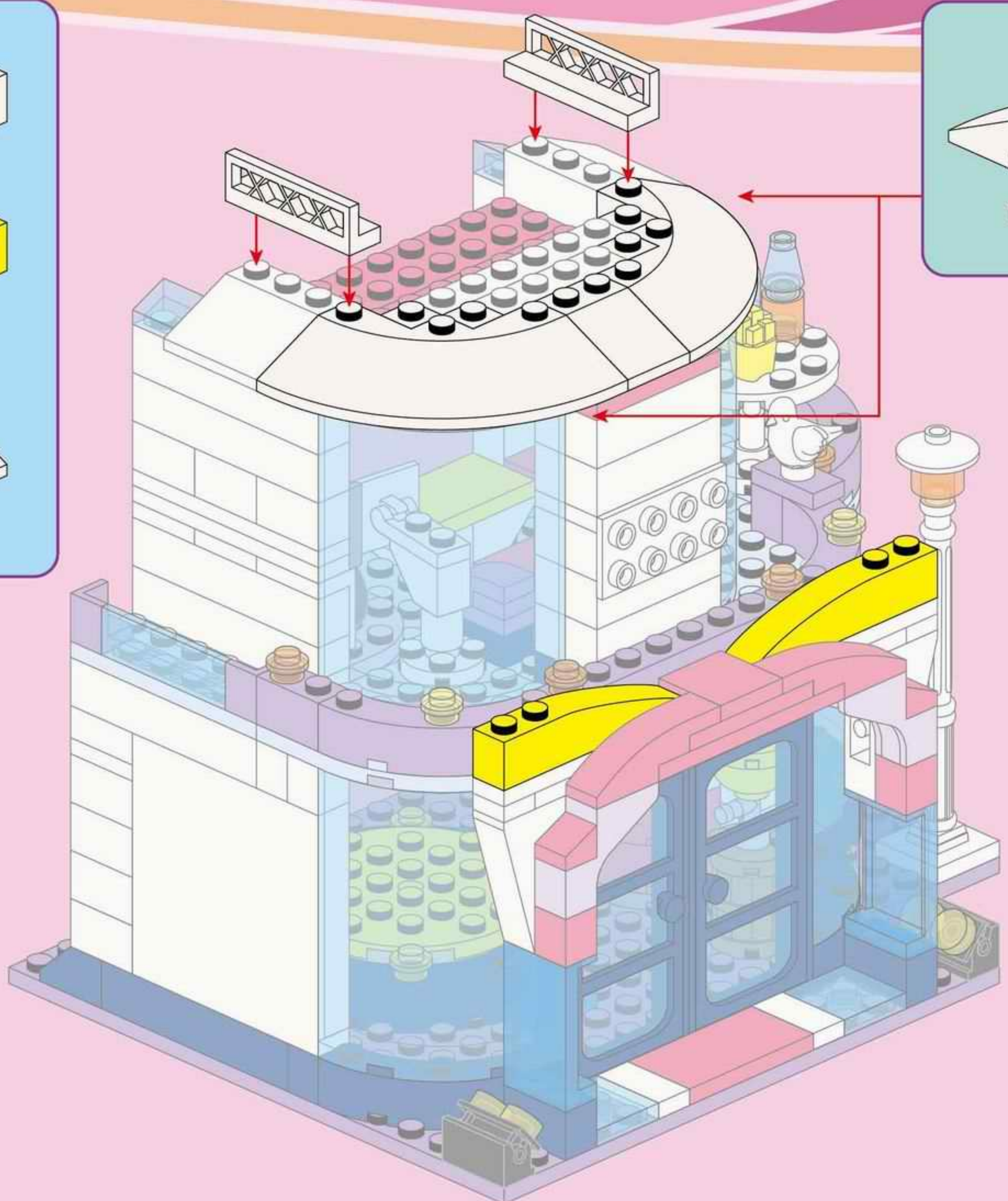

This inset shows the parts required for step 31: two white 1x3 Technic beams with a cross-hatch pattern, one white 1x2 Technic wedge, eight white 1x1 Technic pins, two yellow 1x3 Technic Technic wedges, and two white 1x3 Technic Technic wedges with a curved bottom edge.







2x

This inset diagram shows a close-up of the roof assembly. It illustrates how two white 1x3 Technic Technic wedges with a curved bottom edge are connected to the roof structure using white 1x1 Technic pins. Red arrows point to the specific connection points.

32

2x  4x  4x 

1x  1x 

2x  1x 

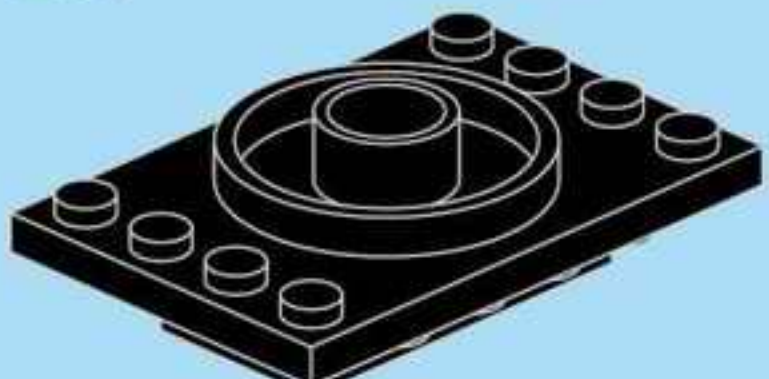
1x 

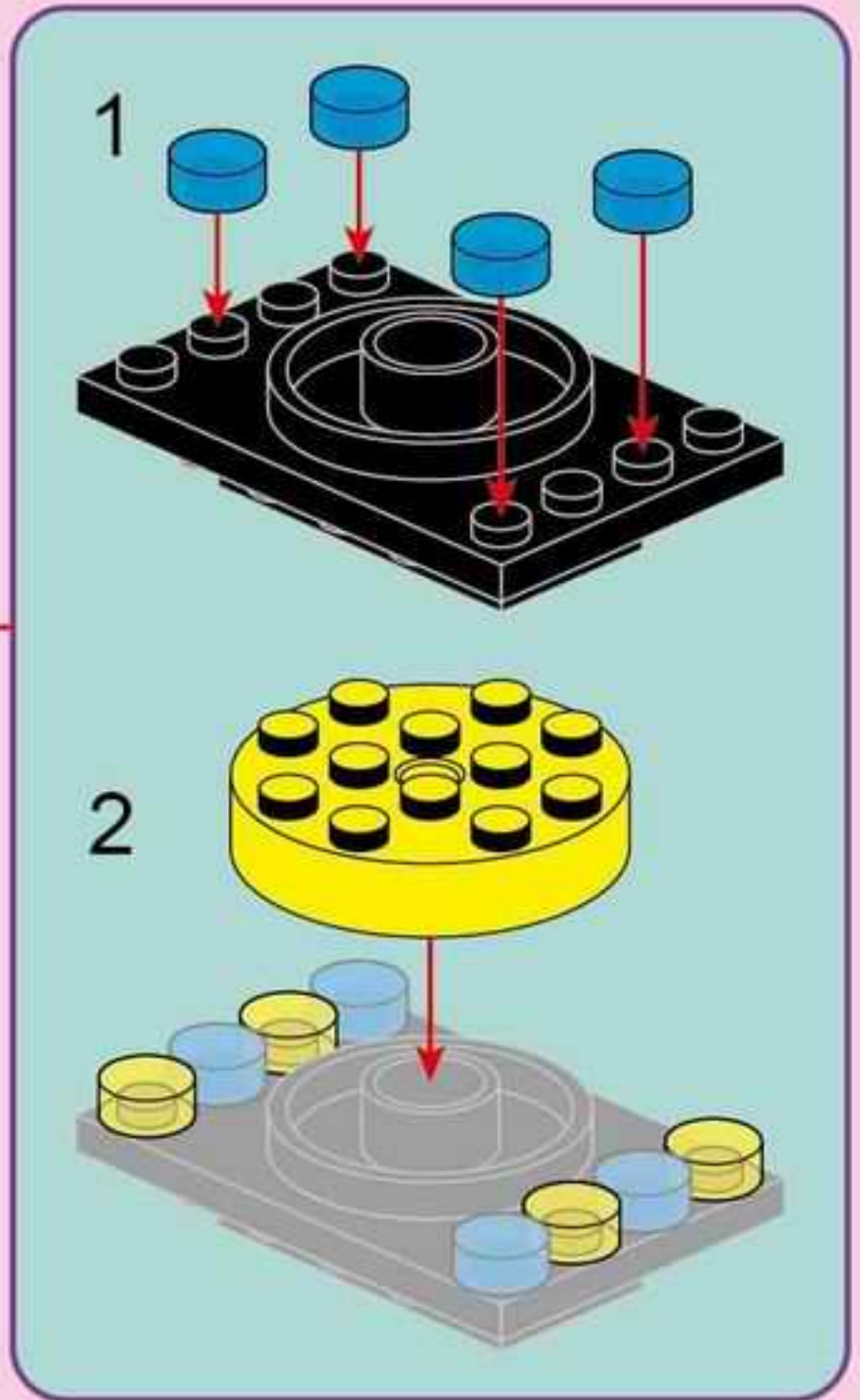
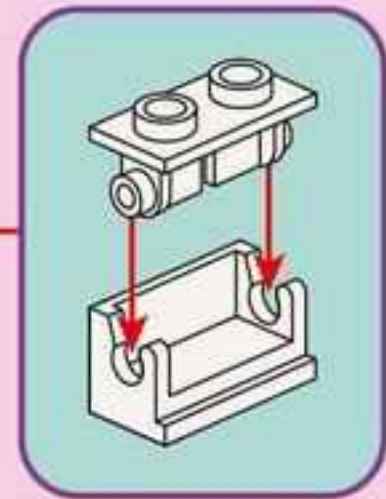

33

1x 4x 1x

1x 1x8

1x 1x10

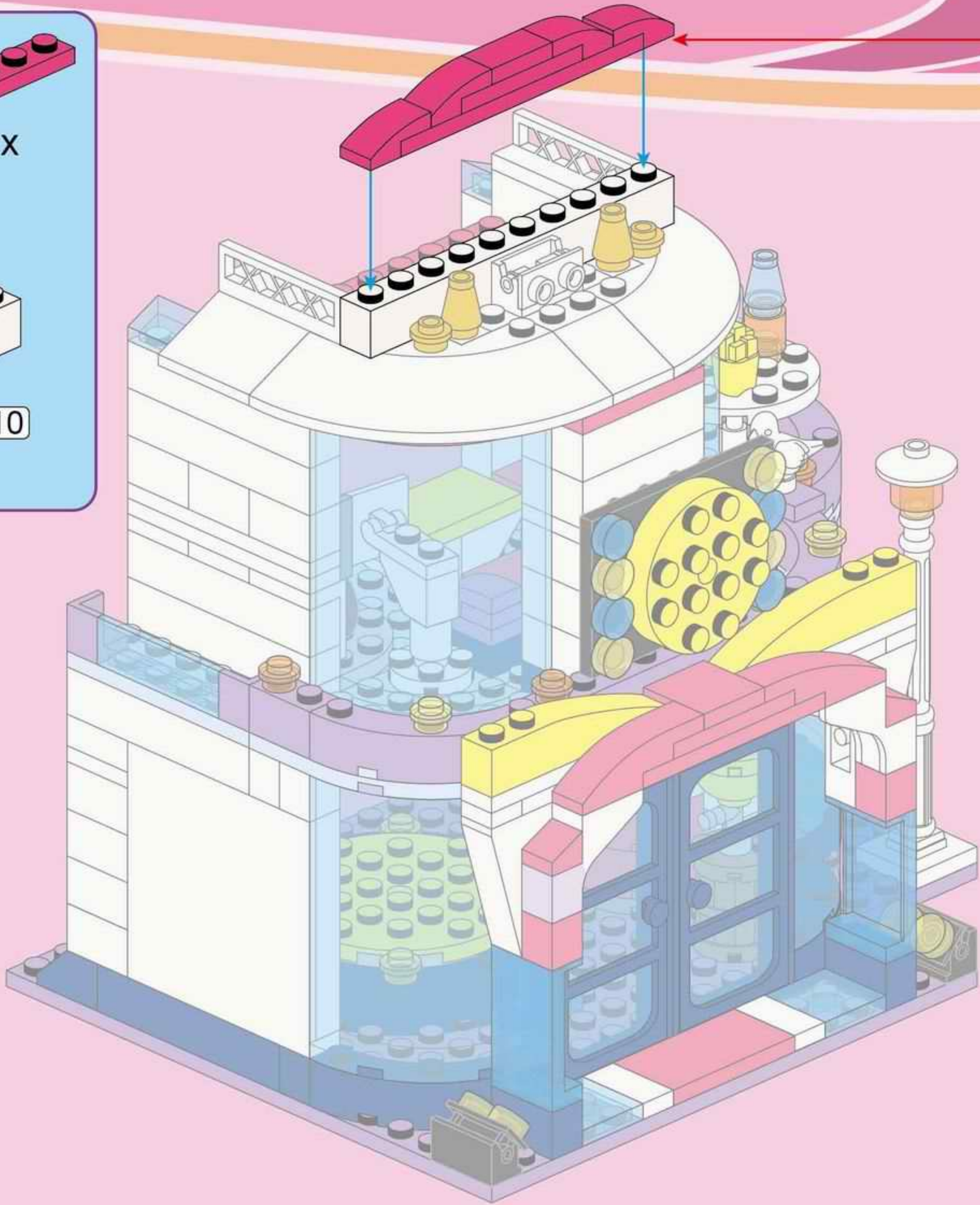

1

2

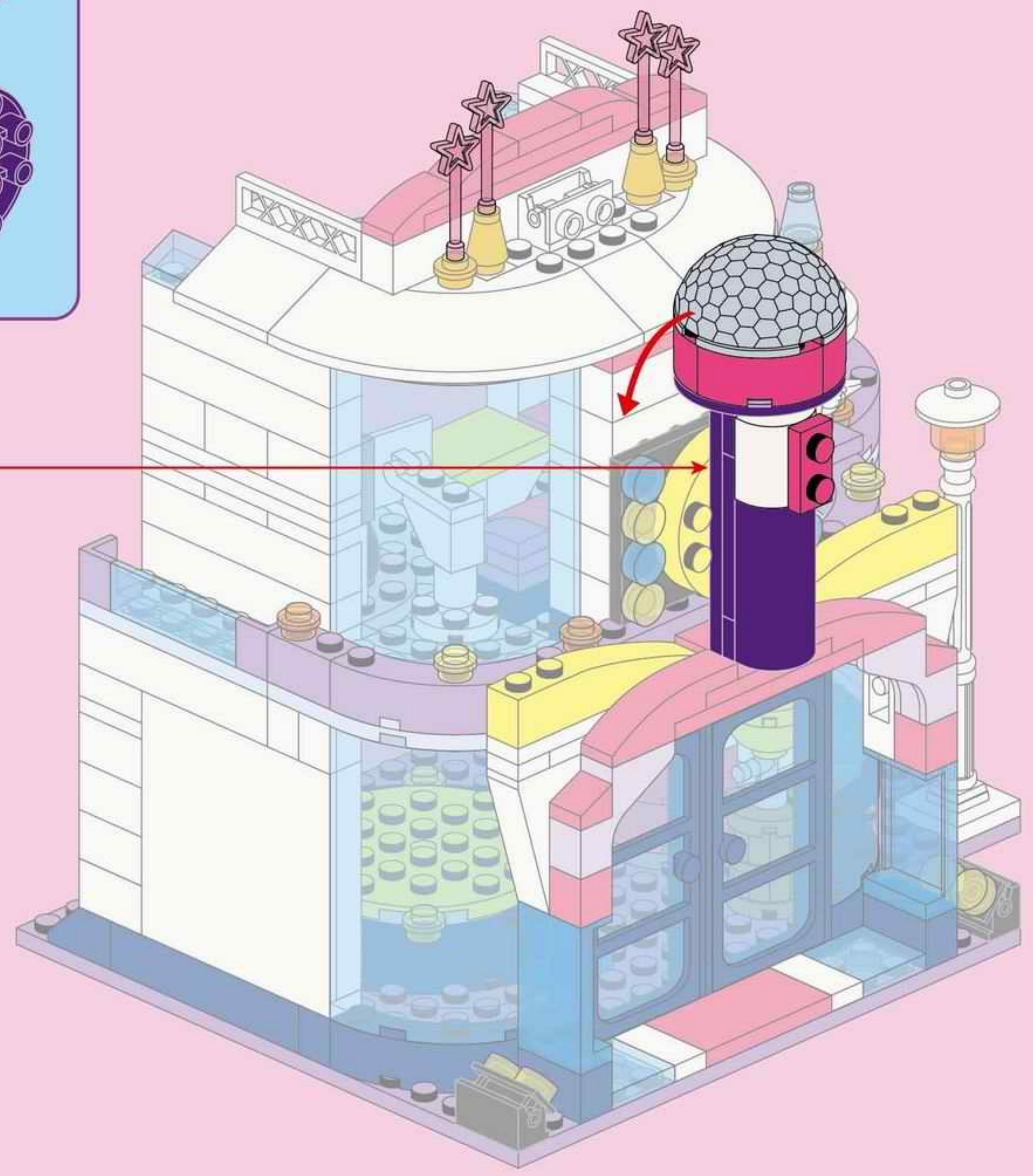
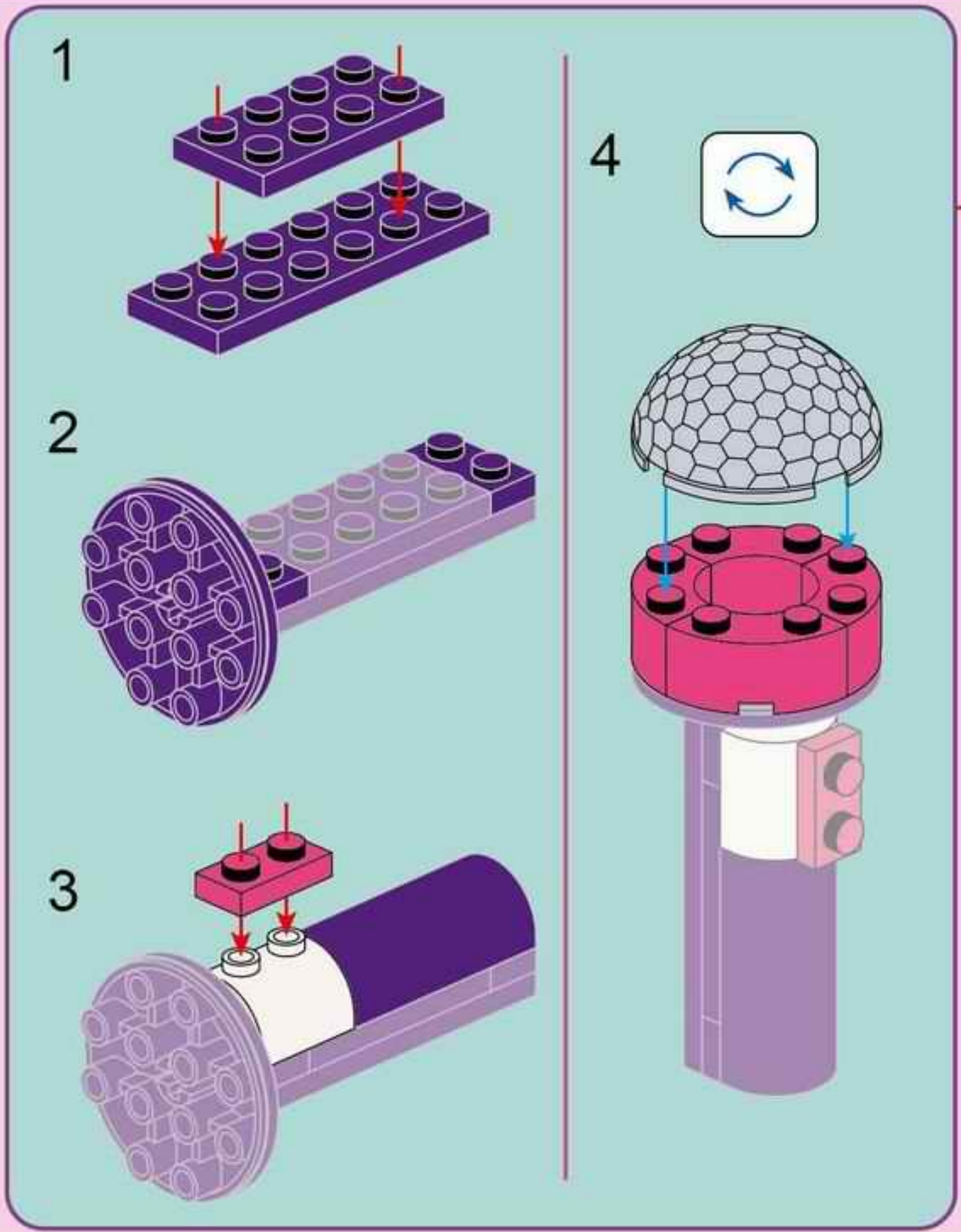
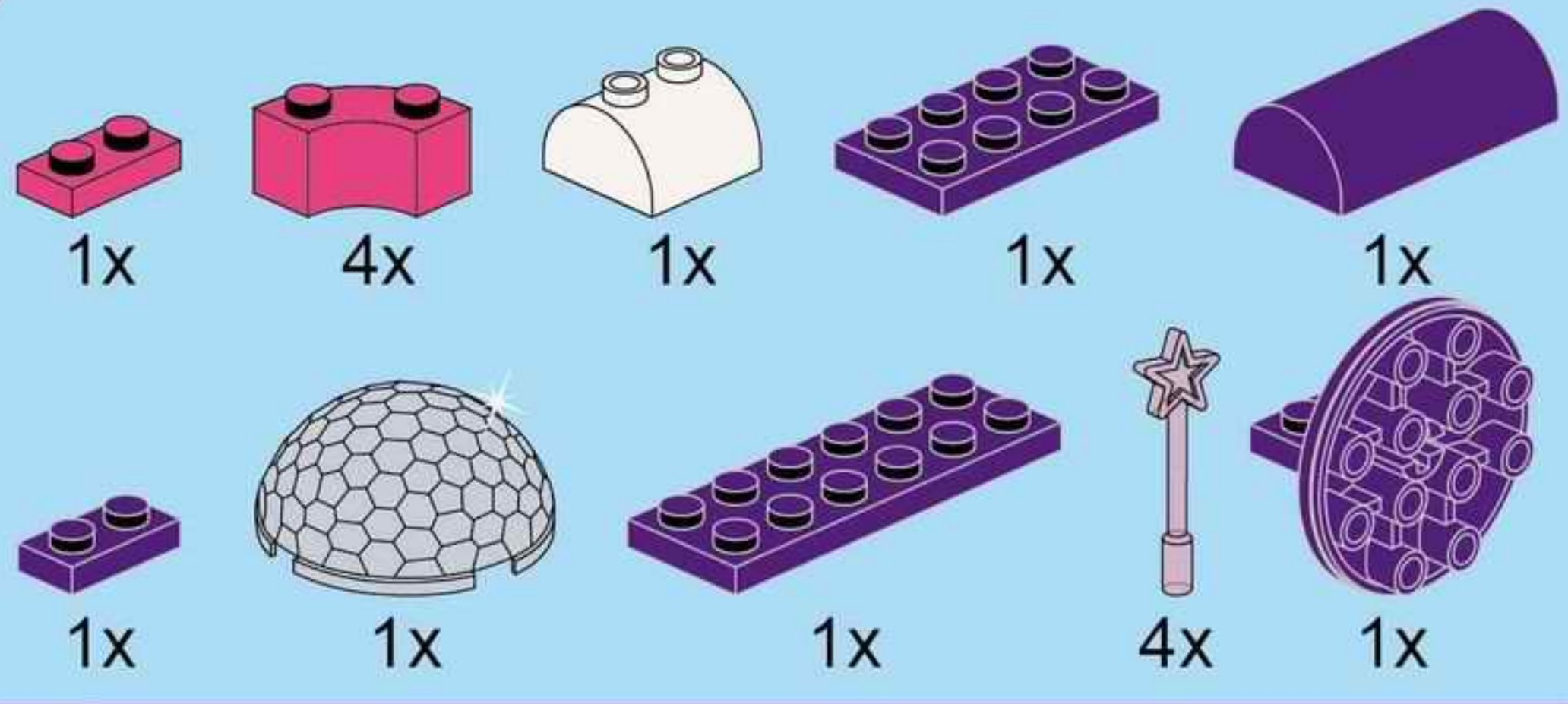

35

