

5

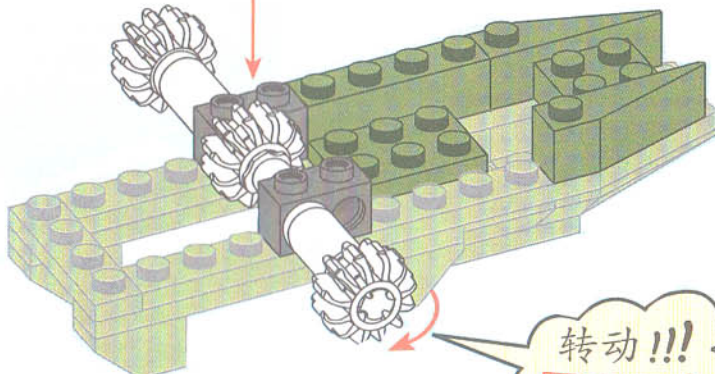

转动!!!
TURN!!!

6

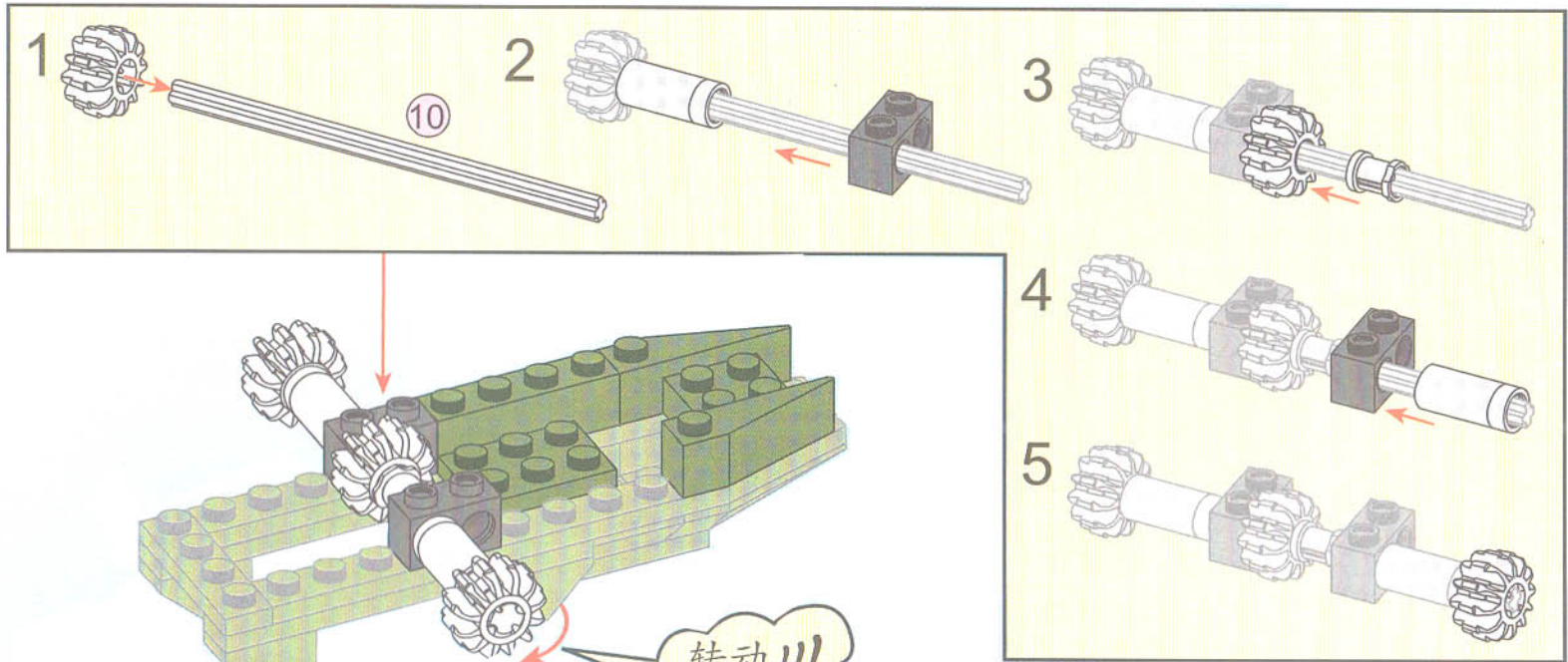
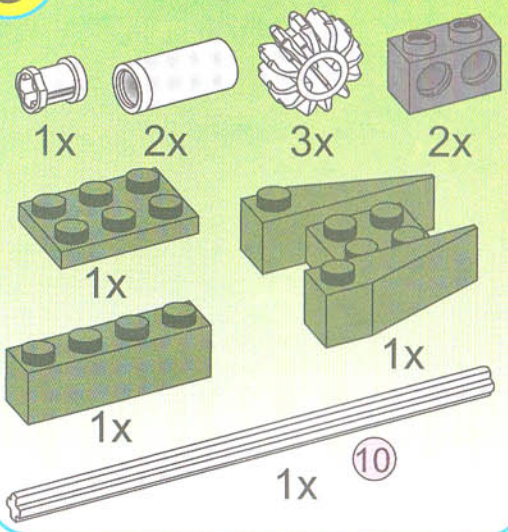
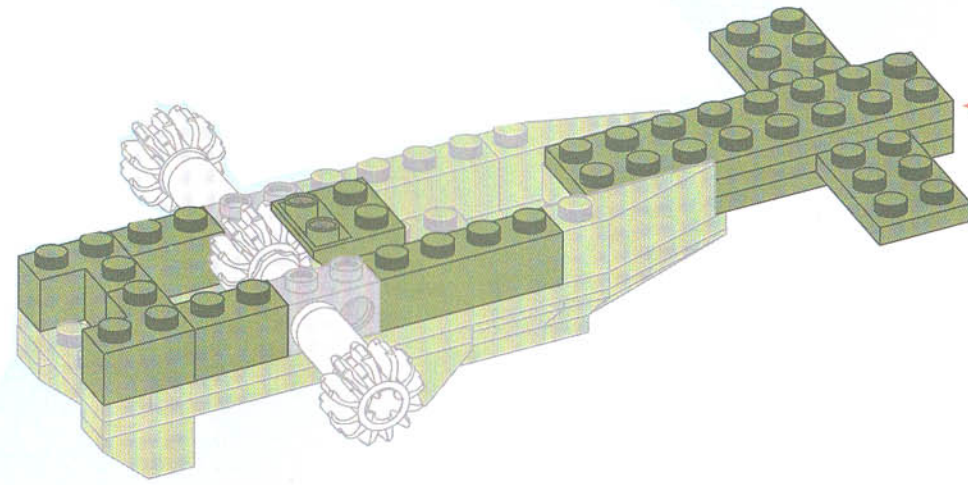
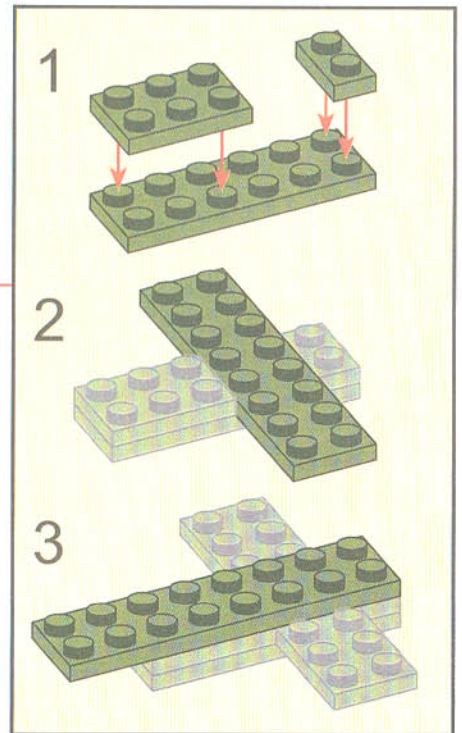
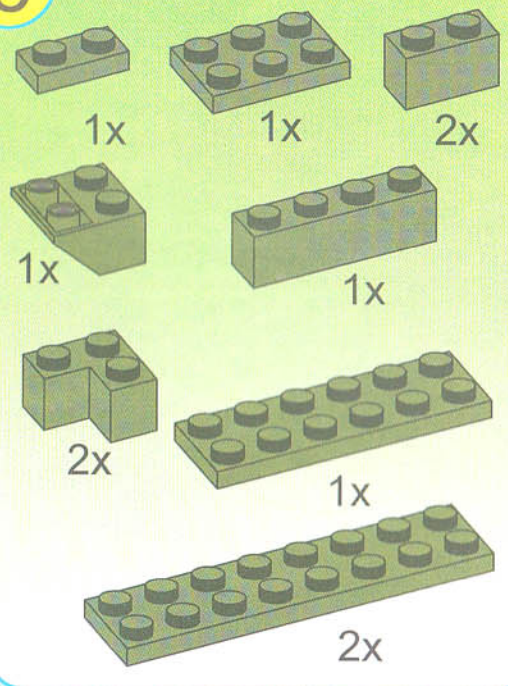

7



1x

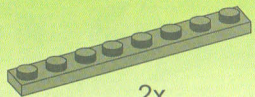

2x



2x

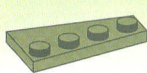

3x

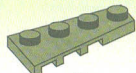

3x

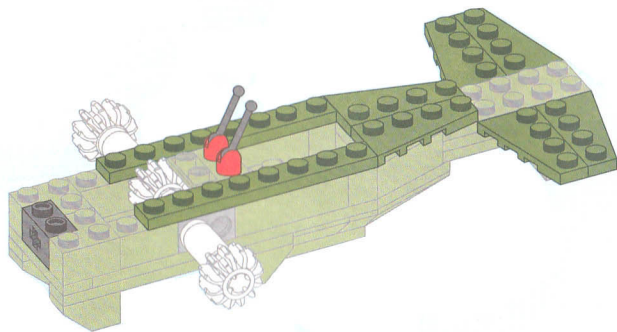

8



2x

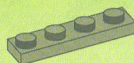

1x

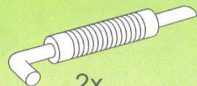

2x



4x

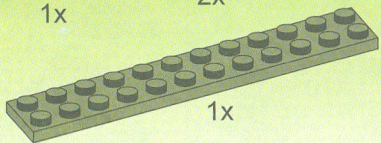

1x

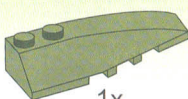

1x

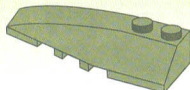

1x

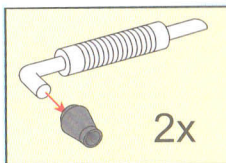

2x

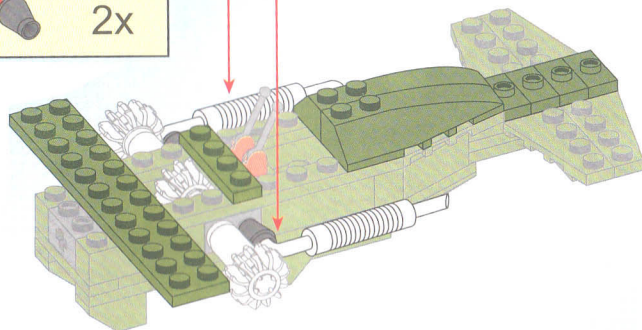

9



2x

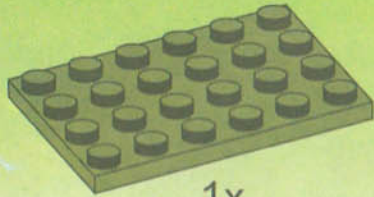

1x



2x

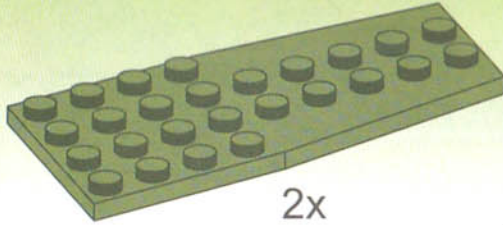

2x

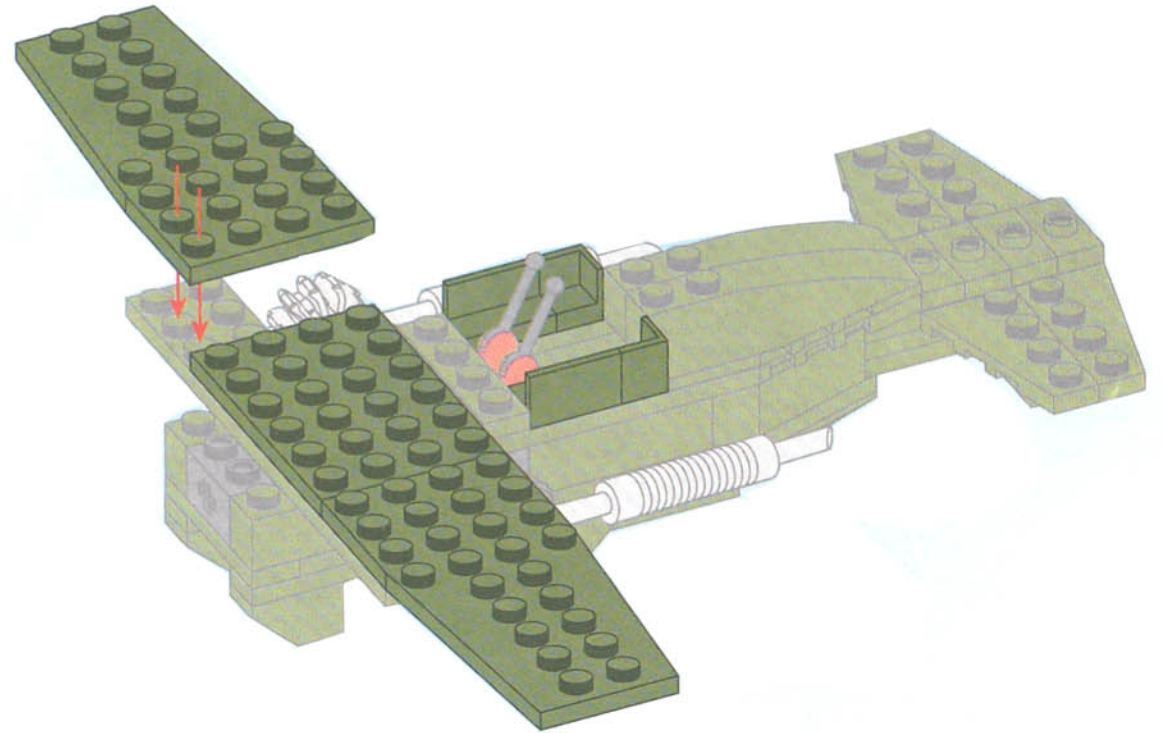

10



4x



2x

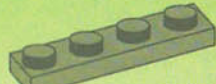

1x



2x



1x

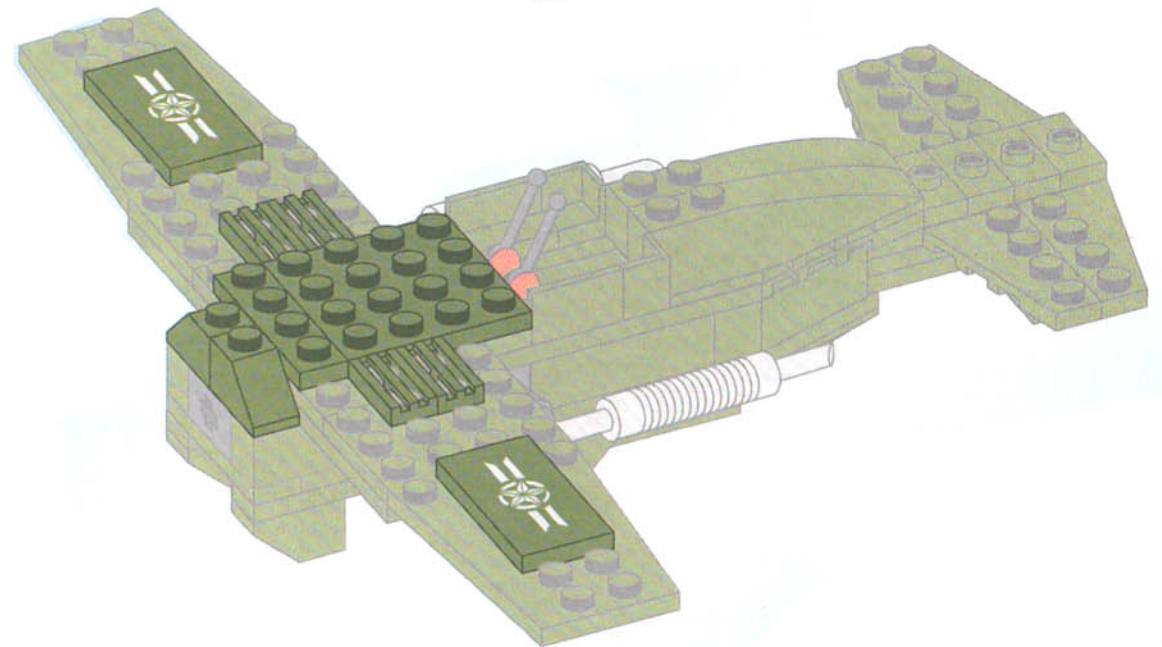

11

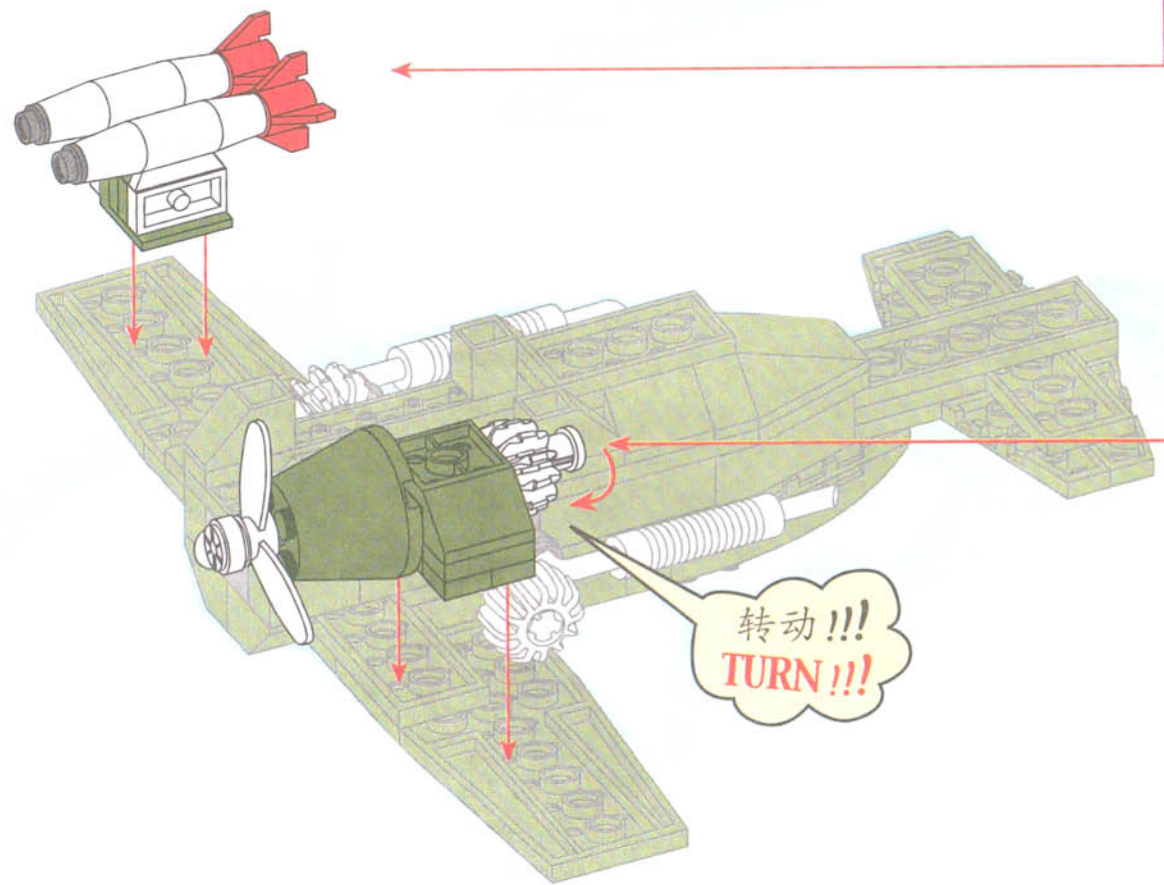
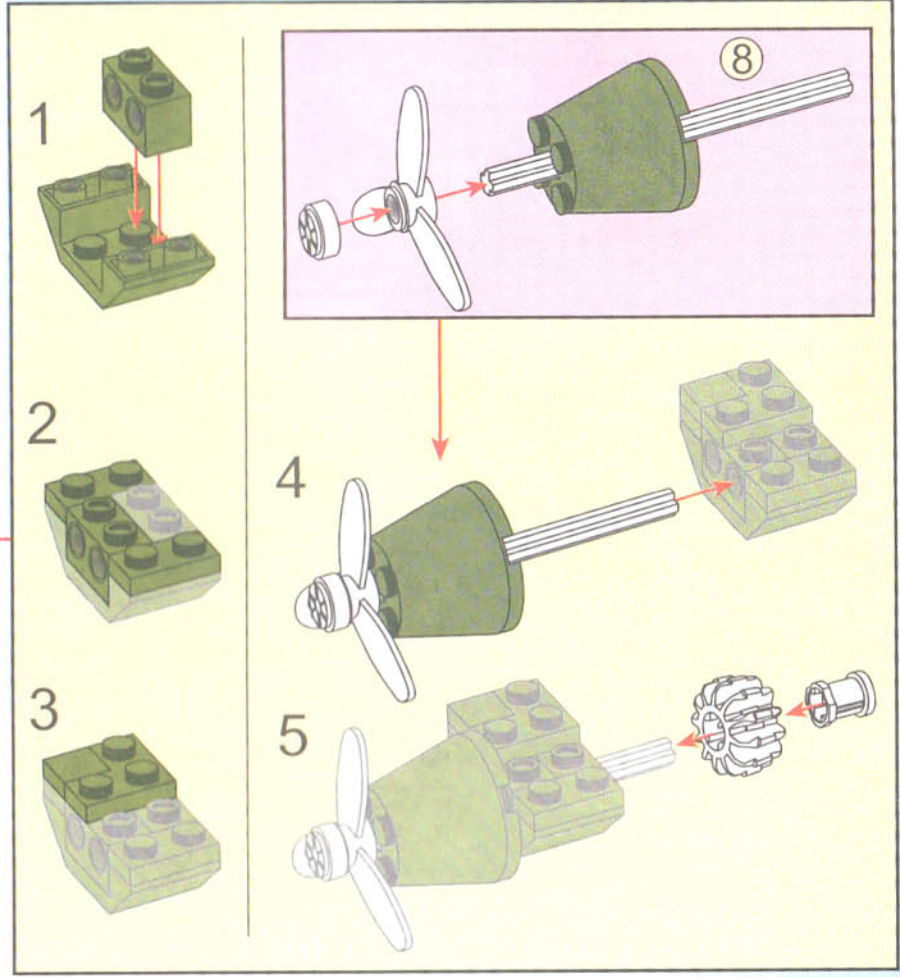
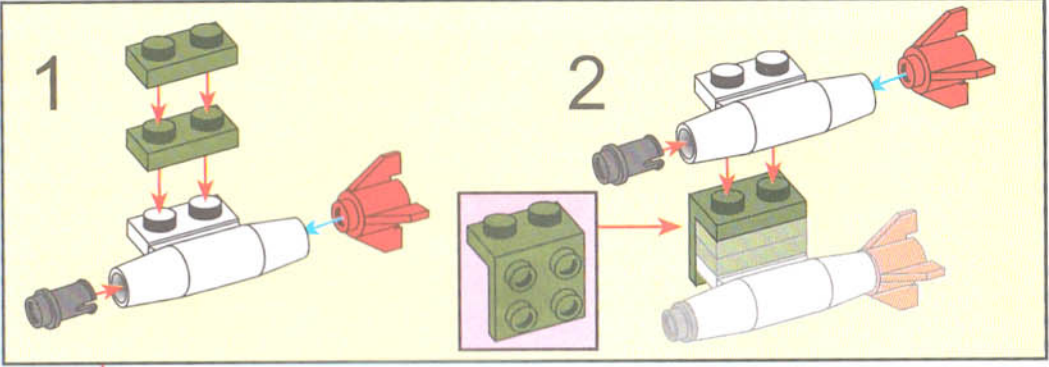
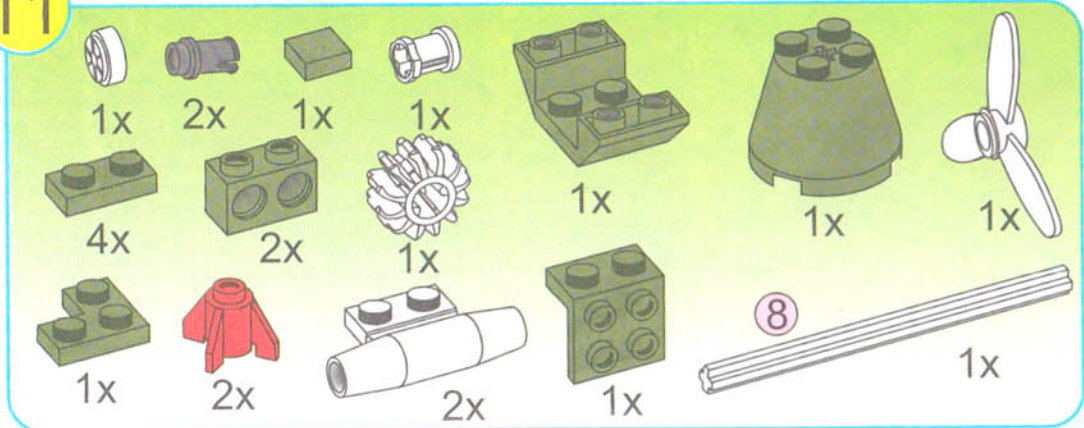

12

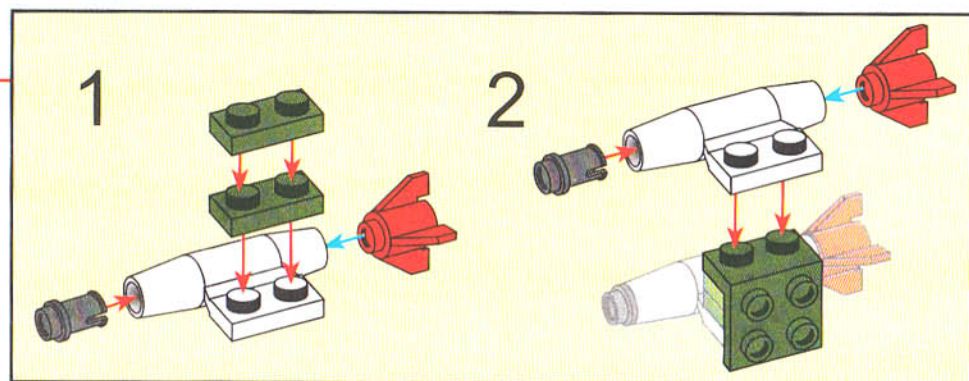
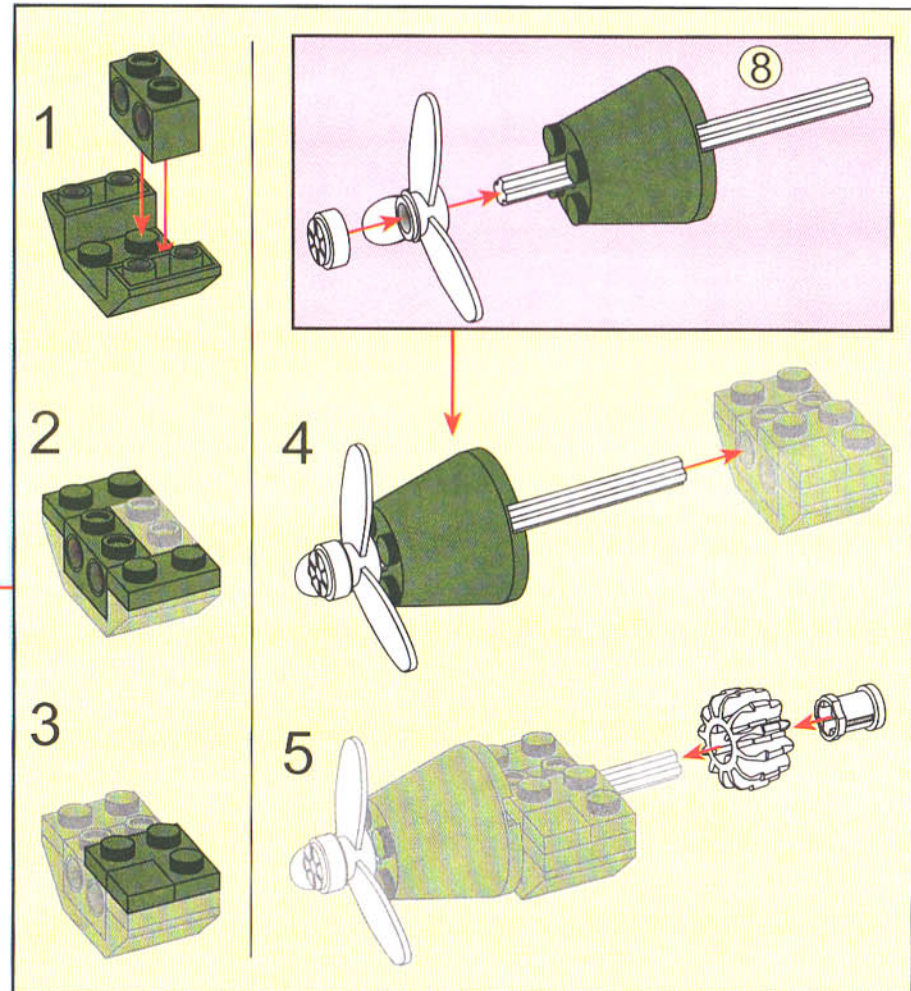
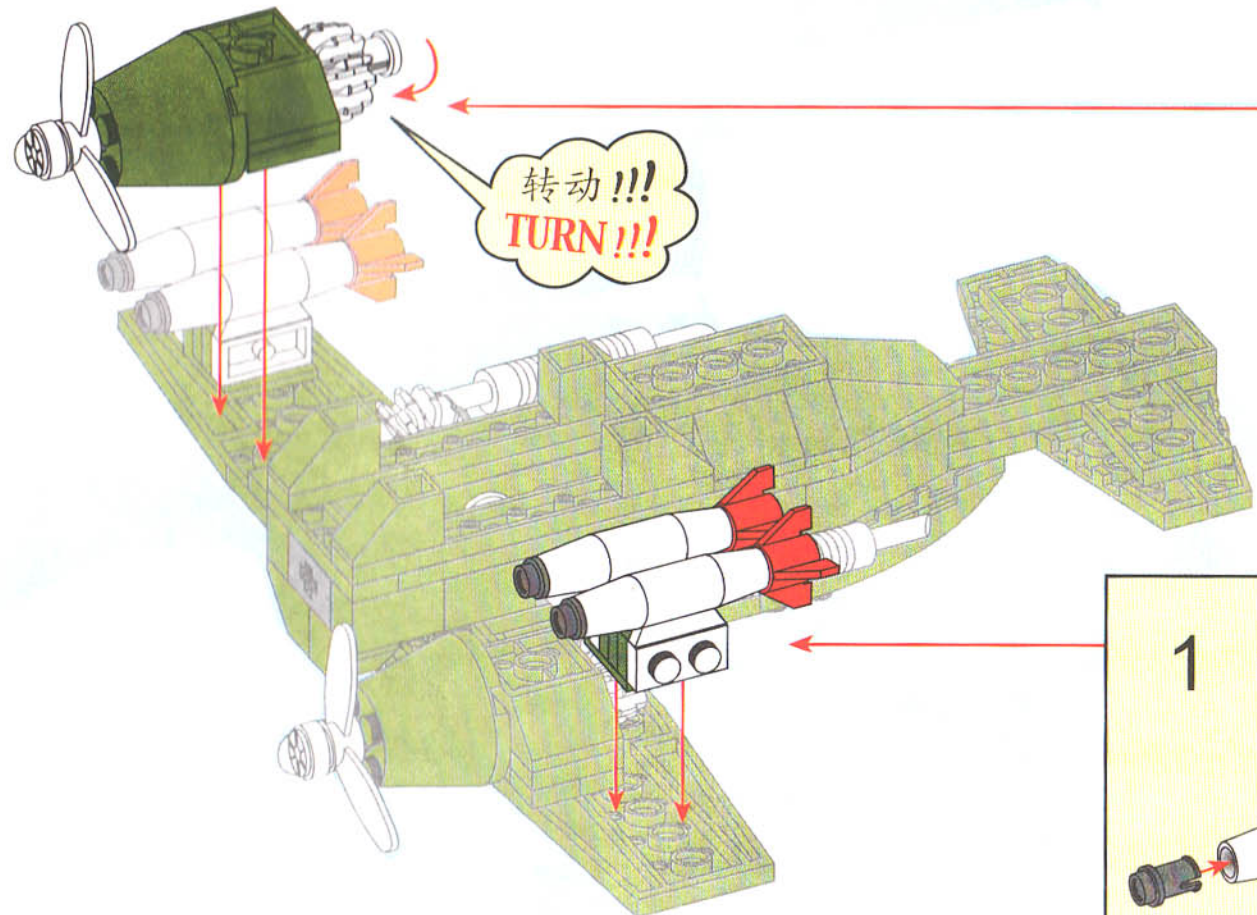
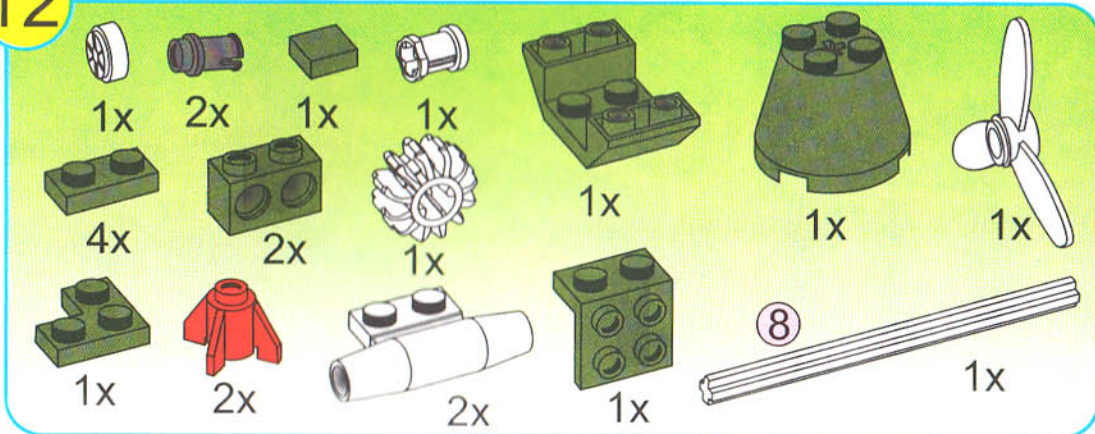

13

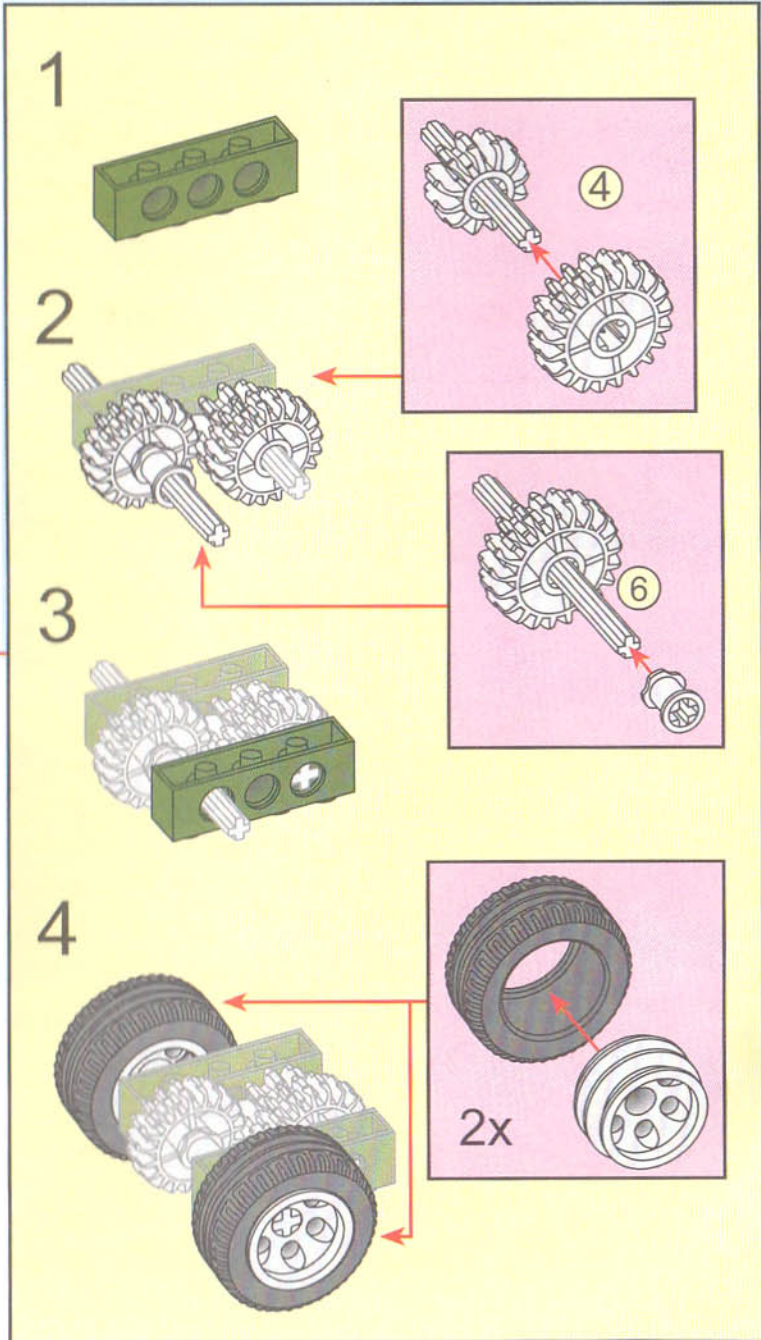
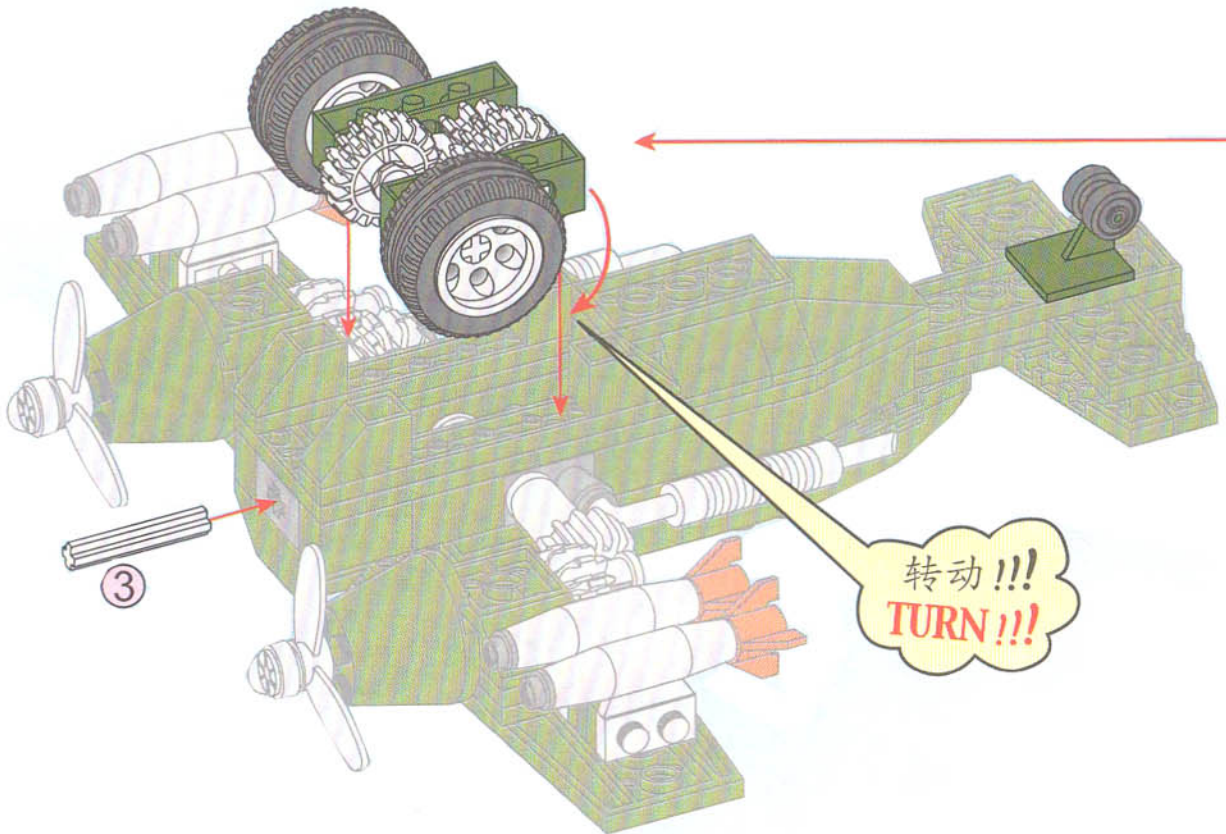
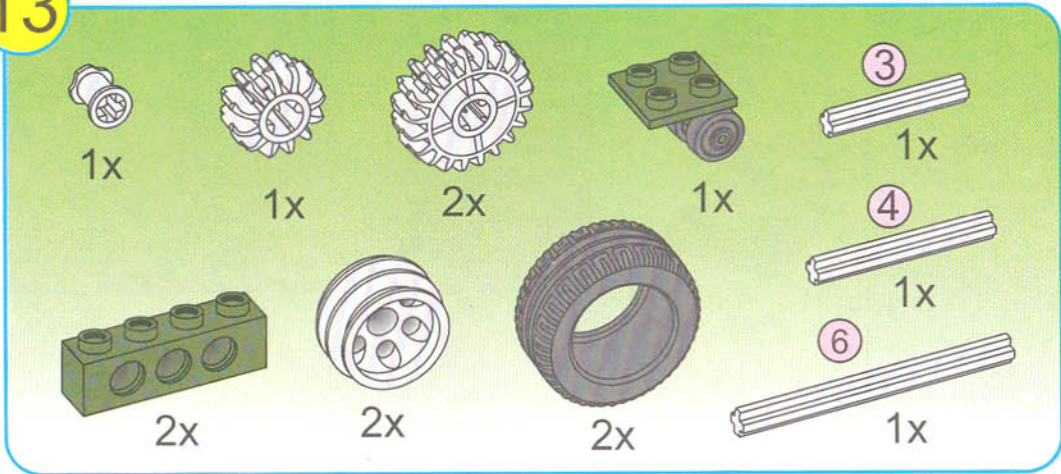

14



1x



2x



1x



1x



1x



1x

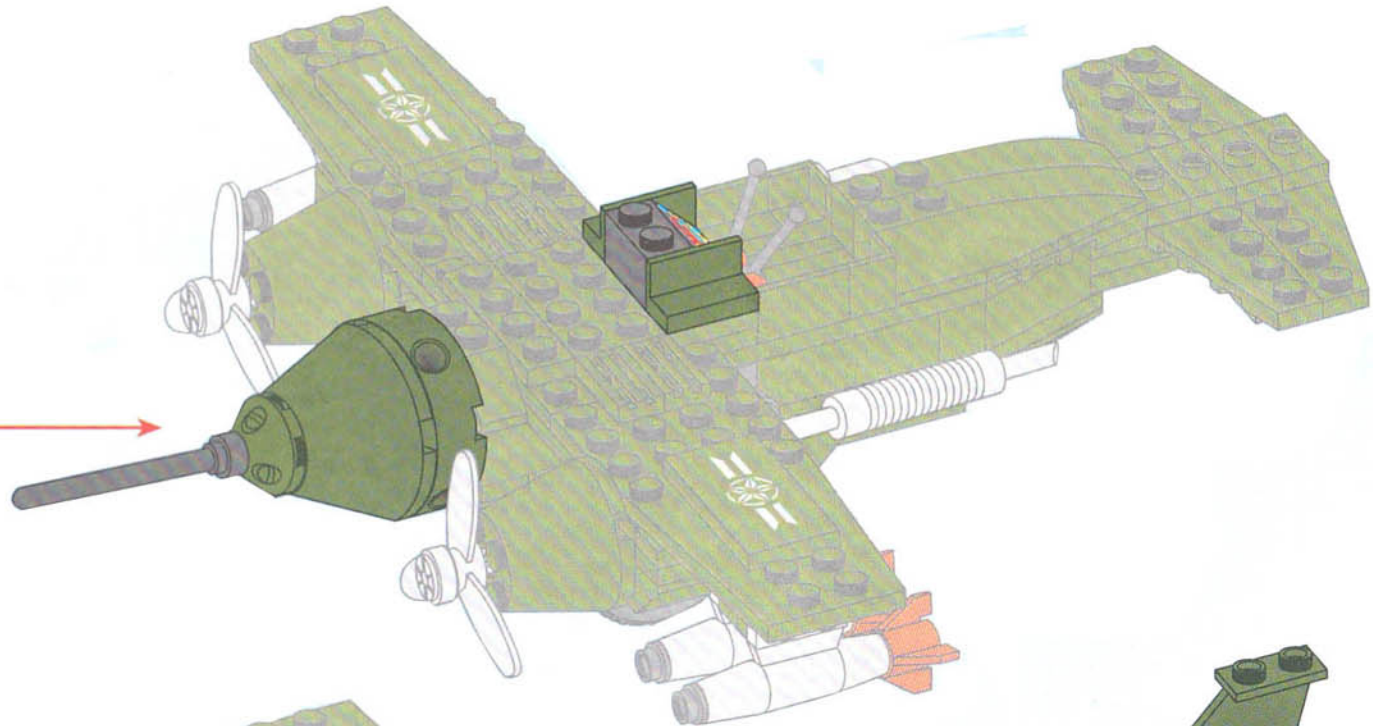
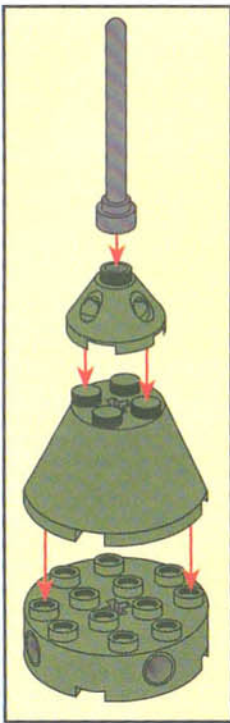

15



1x



1x



1x



1x

